



*Your Enclosure Source*®



®  
**Your Enclosure Source**



**14<sup>TH</sup>**  
EDITION



# Free-Standing & Floor Mounted Enclosures

Enviroline® Series Two-Door Enclosures ..... 118 – 119



Overlapping Two-Door Enclosures ..... 120 – 121



Free-Standing Single-Door, Two-Door, and Dual Access Enclosures ..... 122 – 131



Enviroline® Series Free-Standing Two-Door Enclosures ..... 126 – 127



Free-Standing Enclosure Accessories ..... 132 – 139

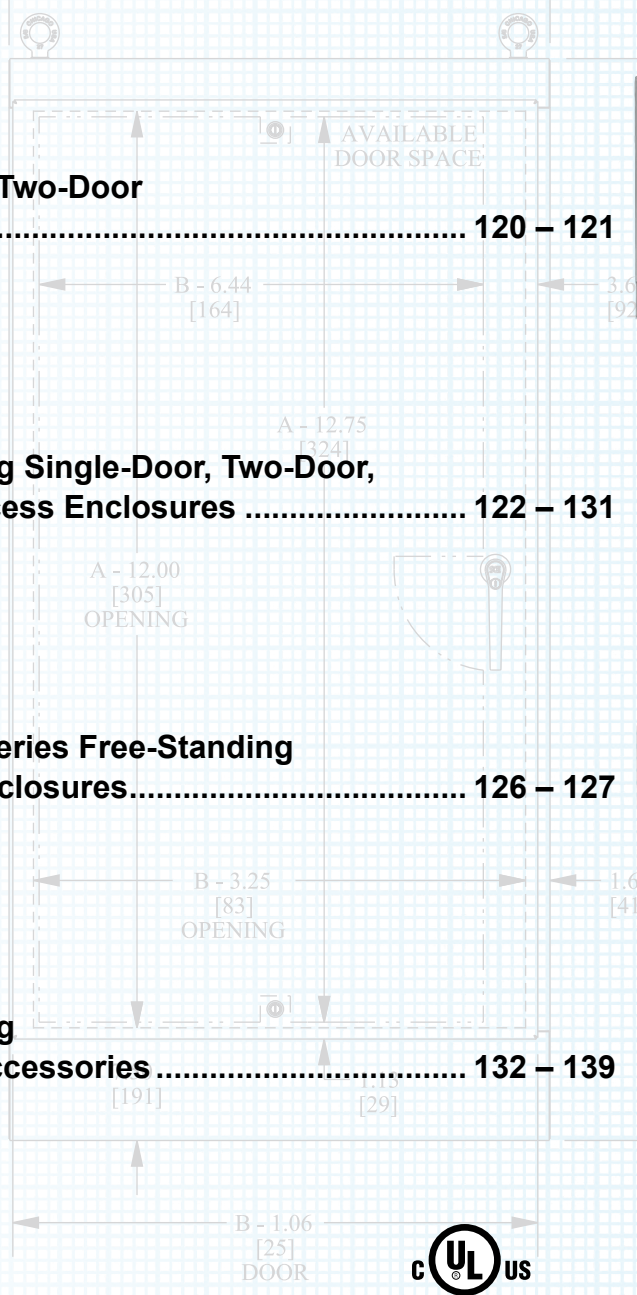
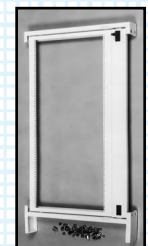

Phone (989) 799-6871  
Fax (989) 799-4524



1 Operator System Enclosures  
2 Wall-Mount Enclosures  
3 Free-Standing & Floor-Mounted Enclosures  
4 Modular Enclosures  
5 Operator System Enclosures (Stainless Steel)  
6 Wall-Mount Enclosures (Stainless Steel)  
7 Free-Standing & Floor-Mounted Enclosures (Stainless Steel)  
8 Non-Metallic Enclosures  
9 Accessories  
10 Technical Information  
11 Index

# Free-Standing & Floor Mounted Enclosures

Multi-Door Three, Four and Five Door Enclosures..... 140 – 143



Multi-Door Free-Standing/Wall-Mount Enclosures for Flange-Mounted Disconnects..... 144 – 149



Enviroline® Series Two-Door Enclosures for Flange-Mounted Disconnects ..... 150 – 151



Heavy Duty Free-Standing Enclosures for Flange-Disconnect Single, Two, Three, Four, Five and Six Door Enclosures ..... 152 – 159



XD Heavy Duty Free-Standing Enclosures with External Disconnect Enclosure Installed Single, Two, and Three Door Enclosures ..... 160 – 164

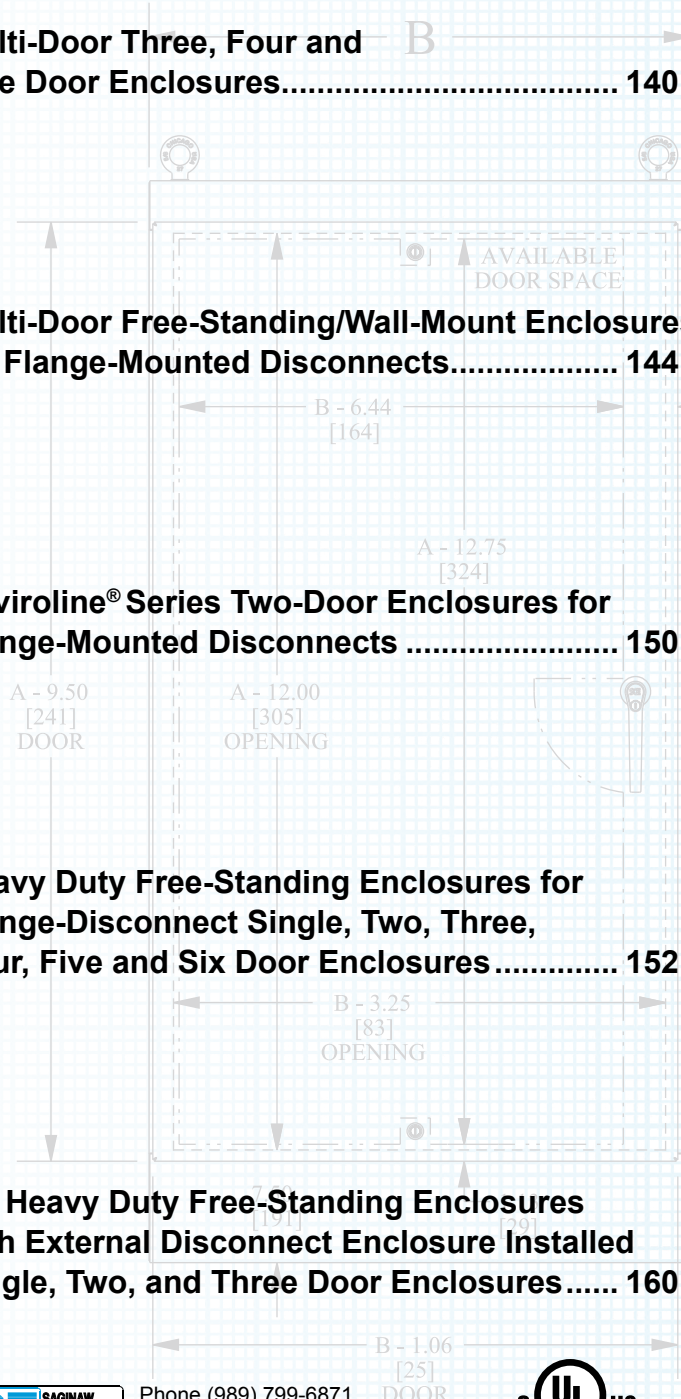
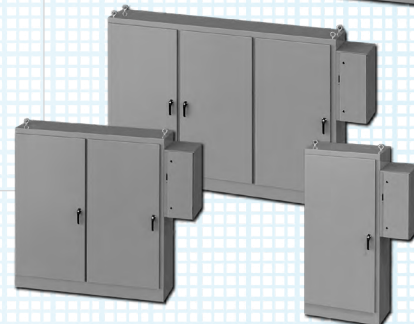

Phone (989) 799-6871  
Fax (989) 799-4524



- 1 Operator System Enclosures
- 2 Wall-Mount Enclosures
- 3 Free-Standing & Floor-Mounted Enclosures
- 4 Modular Enclosures
- 5 Operator System Enclosures (Stainless Steel)
- 6 Wall-Mount Enclosures (Stainless Steel)
- 7 Free-Standing & Floor-Mounted Enclosures (Stainless Steel)
- 8 Non-Metallic Enclosures
- 9 Accessories
- 10 Technical Information
- 11 Index

## Enviroline® Series Two-Door Enclosures With 3-Point Hardware

### Application -

Designed to house electrical and electronic controls, instrumentation and components in indoor & outdoor locations. For outdoor applications a drip shield is recommended. For installation information, consult our Installation Manual at [www.saginawcontrol.com](http://www.saginawcontrol.com).

### Construction -

- 0.104" carbon steel.
- Seams continuously welded and ground smooth.
- Flange trough collar around all sides of door opening.
- Removable center post.
- Heavy duty lifting eyes anchored into reinforced top.
- Body stiffeners.
- Concealed hinges.
- Black keylocking/padlocking handles.
- 3-point latching mechanism.
- Removable print pocket.
- 12" removable floor stands.
- Panel supports.
- Black quarter turn latches as required.
- Provisions for mechanical interlock.
- Oil & water resistant gasket.
- Ground stud on door and body.
- Provisions for light kit.
- Hole plugs provided to seal holes in bottom of enclosure.

### Options -

Provisions for mechanical interlock. See Accessory section to order.

### Finish -

ANSI-61 gray powder coated inside and out. Optional sub-panels powder coated white.

### IS4 - Industry Standards -

NEMA Type 3R, 4, 12 & Type 13  
 UL Listed Type 3R, 4, & 12  
 CSA Type 3R, 4 & 12  
 IEC 60529 IP66

\*\*\*Special Instructions apply for IS3, IS4 and IS6 to maintain the environmental rating of Type 3R for these parts. See the Special Instructions on the Industry Standards page in the Technical Information Section.

## ENVIROLINE® SERIES TWO-DOOR ENCLOSURES WITH 3-POINT HARDWARE

ENCLOSURE PRODUCT CODE E2						SUB-PANEL (P3)			
Catalog No.	Height (A)	Width (B)	Depth (C)	Industry Standard	List Price	Catalog No.	Panel Height (D)	Panel Width (E)	List Price
SCE-60EL4812LPPL	60.00	48.00	12.00	IS4	1,997.80	SCE-60P48	56.00	44.00	268.38
SCE-60EL4818LPPL	60.00	48.00	18.00	IS4	2,037.17	SCE-60P48	56.00	44.00	268.38
SCE-60EL6012LPPL	60.00	60.00	12.00	IS4	2,189.71	SCE-60P60	56.00	56.00	331.68
SCE-60EL6018LPPL	60.00	60.00	18.00	IS4	2,229.09	SCE-60P60	56.00	56.00	331.68
SCE-72EL6012LPPL	72.00	60.00	12.00	IS4	2,448.04	SCE-72P60	68.00	56.00	394.98
SCE-72EL6018LPPL	72.00	60.00	18.00	IS4	2,478.80	SCE-72P60	68.00	56.00	394.98
SCE-72EL7212LPPL	72.00	72.00	12.00	IS4	2,743.30	SCE-72P72	68.00	68.00	470.93
SCE-72EL7218LPPL	72.00	72.00	18.00	IS4	2,817.10	SCE-72P72	68.00	68.00	470.93
SCE-72EL7224LPPL	72.00	72.00	24.00	IS4	3,186.15	SCE-72P72	68.00	68.00	470.93



Phone (989) 799-6871  
 Fax (989) 799-4524



# ENVIROLINE® SERIES TWO-DOOR ENCLOSURES WITH 3-POINT HARDWARE TECHNICAL DATA

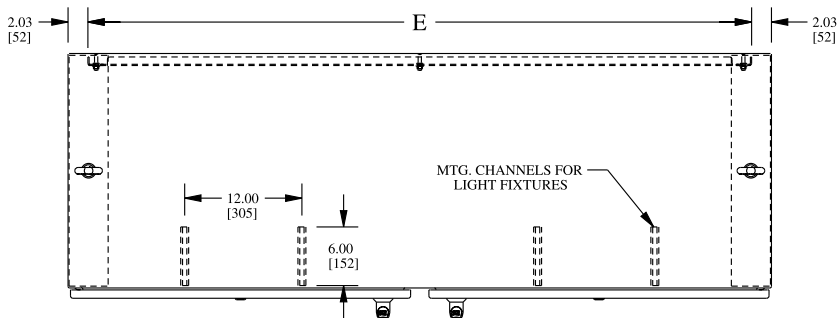

**LATCH NOTE:**  
Omit center latch top and bottom of door when door width is  $< 30.00$  [762]

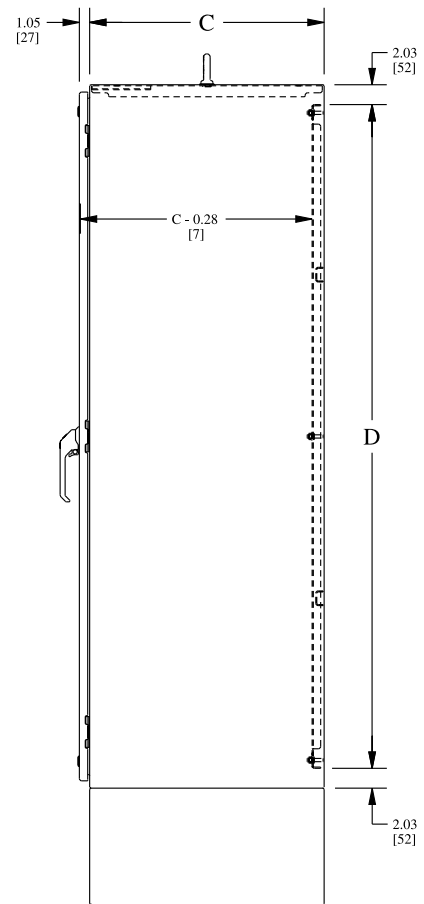
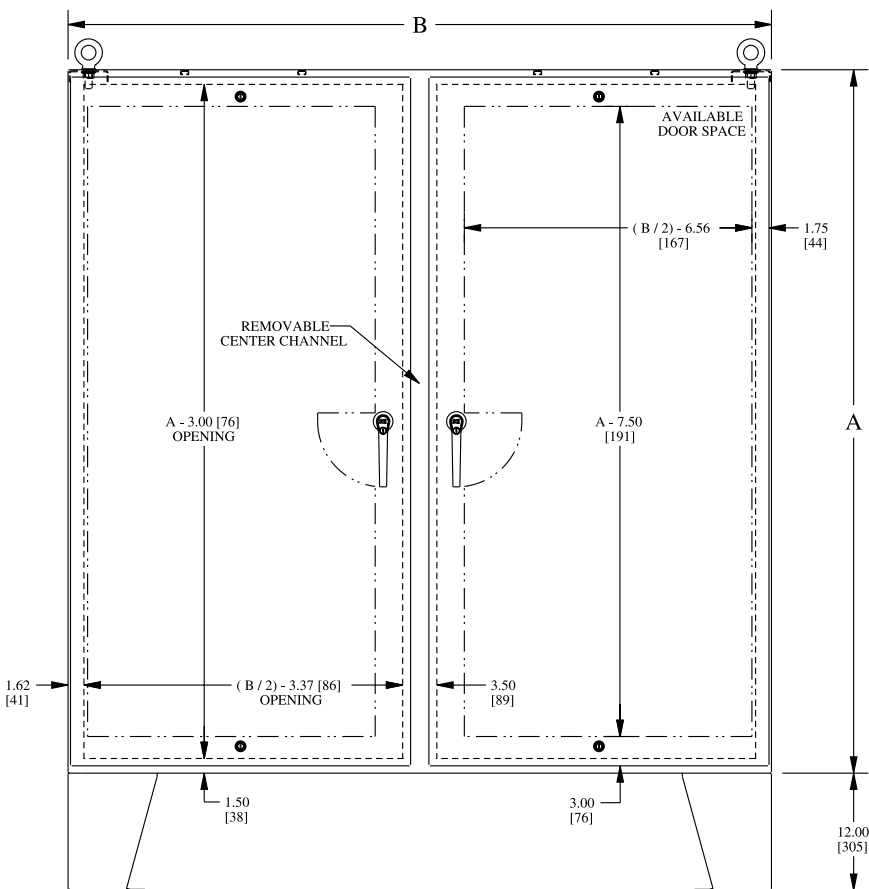

Phone (989) 799-6871  
Fax (989) 799-4524

## Overlapping Two-Door Enclosures

### Application -

Designed to house electrical and electronic controls, instruments and components. Provides protection from dust, oil and water. For outdoor application a drip shield and drain holes are required. For installation information, consult our Installation Manual at [www.saginawcontrol.com](http://www.saginawcontrol.com).

### Construction -

- 0.104" carbon steel.
- Seams continuously welded and ground smooth, no holes or knockouts.
- Strong, rigid construction with body stiffeners.
- Gasketed overlapping doors eliminate need for center post.
- Black zinc die cast keylocking/padlocking handle.
- 3-point latching mechanism.
- Latch rods ramp shoes for easier door closing.
- Concealed hinges.
- Removable print pocket.
- 12" removable floor stands.
- Heavy duty lifting eyes.
- Panel supports.
- Oil resistant door gasket.
- Collar studs for mounting optional sub-panel.
- Ground stud on door and body.
- Provisions for light kit.
- Hole plugs provided to seal holes in bottom of enclosure.

### Finish -

ANSI-61 gray powder coated inside and out. Optional sub-panels powder coated white.

### IS3 - Industry Standards -

NEMA Type 3R, 12 & Type 13  
 UL Listed Type 3R & 12  
 CSA Type 3R & 12  
 IEC 60529 IP55

\*\*\*Special Instructions apply for IS3, IS4 and IS6 to maintain the environmental rating of Type 3R for these parts. See the Special Instructions on the Industry Standards page in the Technical Information Section.

## OVERLAPPING TWO-DOOR ENCLOSURES

ENCLOSURE PRODUCT CODE A2						SUB-PANEL (P3)			
Catalog No.	Height (A)	Width (B)	Depth (C)	Industry Standard	List Price	Catalog No.	Panel Height (D)	Panel Width (E)	List Price
SCE-604808LP	60.00	48.00	8.00	IS3	1,491.36	SCE-60P48	56.00	44.00	268.38
SCE-604810LP	60.00	48.00	10.00	IS3	1,539.46	SCE-60P48	56.00	44.00	268.38
SCE-604812LP	60.00	48.00	12.00	IS3	1,587.57	SCE-60P48	56.00	44.00	268.38
SCE-604816LP	60.00	48.00	16.00	IS3	1,681.26	SCE-60P48	56.00	44.00	268.38
SCE-604824LP	60.00	48.00	24.00	IS3	1,873.69	SCE-60P48	56.00	44.00	268.38
SCE-606010LP	60.00	60.00	10.00	IS3	1,724.30	SCE-60P60	56.00	56.00	331.68
SCE-606012LP	60.00	60.00	12.00	IS3	1,777.47	SCE-60P60	56.00	56.00	331.68
SCE-606016LP	60.00	60.00	16.00	IS3	1,883.81	SCE-60P60	56.00	56.00	331.68
SCE-606024LP	60.00	60.00	24.00	IS3	2,096.51	SCE-60P60	56.00	56.00	331.68
SCE-726010ULP	72.00	60.00	10.00	IS3	1,972.44	SCE-72P60	68.00	56.00	394.98
SCE-726012ULP	72.00	60.00	12.00	IS3	2,033.21	SCE-72P60	68.00	56.00	394.98
SCE-726016ULP	72.00	60.00	16.00	IS3	2,152.21	SCE-72P60	68.00	56.00	394.98
SCE-726024ULP	72.00	60.00	24.00	IS3	2,395.28	SCE-72P60	68.00	56.00	394.98
SCE-727210ULP	72.00	72.00	10.00	IS3	2,197.78	SCE-72P72	68.00	68.00	470.93
SCE-727212ULP	72.00	72.00	12.00	IS3	2,263.61	SCE-72P72	68.00	68.00	470.93
SCE-727216ULP	72.00	72.00	16.00	IS3	2,395.28	SCE-72P72	68.00	68.00	470.93
SCE-727224ULP	72.00	72.00	24.00	IS3	2,658.62	SCE-72P72	68.00	68.00	470.93



Phone (989) 799-6871  
 Fax (989) 799-4524



# OVERLAPPING TWO-DOOR ENCLOSURES TECHNICAL DATA

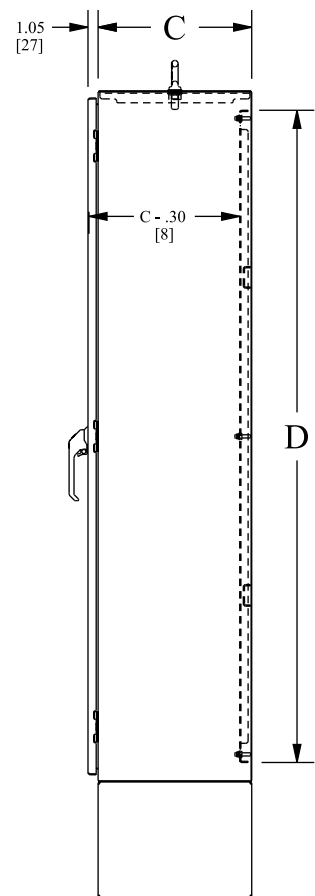
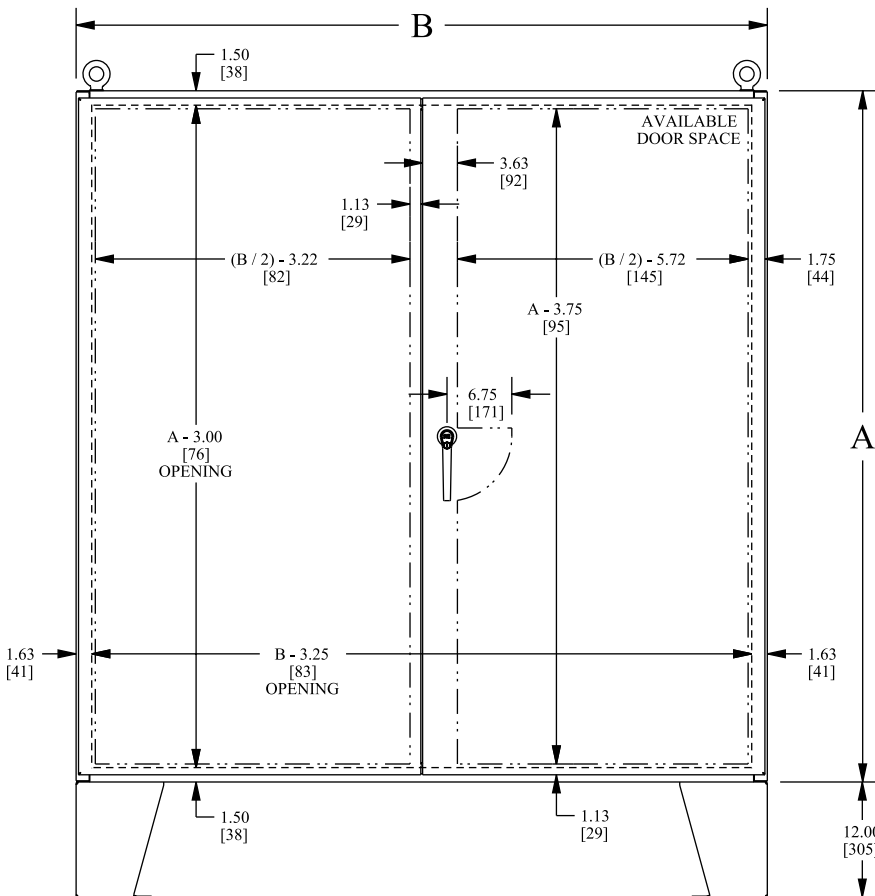
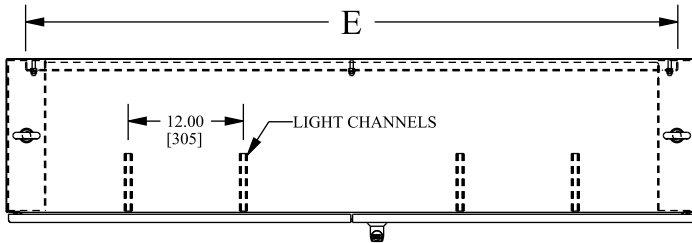

Phone (989) 799-6871  
Fax (989) 799-4524

- 1 Operator System Enclosures
- 2 Wall-Mount Enclosures
- 3 Free-Standing & Floor-Mounted Enclosures
- 4 Modular Enclosures
- 5 Operator System Enclosures (Stainless Steel)
- 6 Wall-Mount Enclosures (Stainless Steel)
- 7 Free-Standing & Floor-Mounted Enclosures (Stainless Steel)
- 8 Non-Metallic Enclosures
- 9 Accessories
- 10 Technical Information
- 11 Index

## Free-Standing Single-Door Single Access Enclosures

### Application -

Designed to house a variety of electrical and electronic controls and instruments. Provisions for optional surface mounting or rack mounting of almost any type of equipment. Provides protection from dust, dirt, water and oil. For outdoor application a drip shield and drain holes are required. The enclosures are extra deep for applications requiring more interior space. For installation information, consult our Installation Manual at www.saginawcontrol.com.

### Construction -

- 0.104" carbon steel.
- Concealed hinges.
- Removable and interchangeable doors.
- Flange trough collar around all sides of door opening.
- Seams continuously welded and ground smooth, no holes or knockouts.
- Lifting eyes for easy handling.
- Black zinc die cast keylocking/padlocking handle.
- 3-point latching mechanism.
- Latch rods have ramp shoes for easier door closing.
- Removable print pocket provided on door.
- Black quarter turn latches as required.
- Mounting channels welded horizontally on sides of interior body at top, bottom and middle for mounting optional panels or rack mounting angles.
- Hole plugs provided to seal holes in bottom of enclosure.
- Oil resistant gasket.
- Ground stud on door and body.
- Provisions for light kit.

### Finish -

ANSI-61 gray powder coated inside and out. Optional sub-panels powder coated white.

### Accessories - See page 132

#### IS3 - Industry Standards -

NEMA Type 3R, 12 & Type 13  
 UL Listed Type 3R & 12  
 CSA Type 3R & 12  
 IEC 60529 IP55

#### IS4 - Industry Standards -

NEMA Type 3R, 4, 12 & Type 13  
 UL Listed Type 3R, 4 & 12  
 CSA Type 3R, 4 & 12  
 IEC 60529 IP66

\*\*\*Special Instructions apply for IS3, IS4 and IS6 to maintain the environmental rating of Type 3R for these parts. See the Special Instructions on the Industry Standards page in the Technical Information Section.

## FREE-STANDING SINGLE-DOOR SINGLE ACCESS ENCLOSURES

ENCLOSURE PRODUCT CODE A2					
Catalog No.	Height (A)	Width (B)	Depth (C)	Industry Standard	List Price
SCE-60EL2418FS	60.00	24.00	18.00	IS4	1,024.17
SCE-603624FS	60.00	36.00	24.00	IS3	1,356.97
SCE-72EL2418FS	72.00	24.00	18.00	IS4	1,135.10
SCE-72EL2424FS	72.00	24.00	24.00	IS4	1,261.50
SCE-72EL3018FS	72.00	30.00	18.00	IS4	1,251.20
SCE-72EL3024FS	72.00	30.00	24.00	IS4	1,387.93
SCE-723618FS	72.00	36.00	18.00	IS3	1,372.44
SCE-72EL3624FS	72.00	36.00	24.00	IS4	1,559.76
SCE-723624FS	72.00	36.00	24.00	IS3	1,514.33
SCE-723630FS	72.00	36.00	30.00	IS3	1,658.80
SCE-723636FS	72.00	36.00	36.00	IS3	1,800.69
SCE-90EL2420FS	90.00	24.00	20.00	IS4	1,351.80
SCE-903620FS	90.00	36.00	20.00	IS3	1,640.75
SCE-903624FS	90.00	36.00	24.00	IS3	1,754.25
SCE-903636FS	90.00	36.00	36.00	IS3	2,087.04

Part numbers that contain the letter "EL" with doors that are over 30 Inches wide have quarter turn latches on the center of the door top and bottom.



Phone (989) 799-6871  
 Fax (989) 799-4524





# FREE-STANDING SINGLE-DOOR SINGLE ACCESS ENCLOSURES TECHNICAL DATA

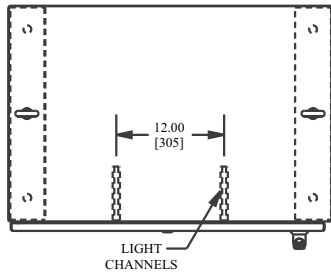

**LATCH NOTE:**

“EL” part numbers with doors  $\geq 30.00$  [762] in width have additional latch centered top and bottom of door.

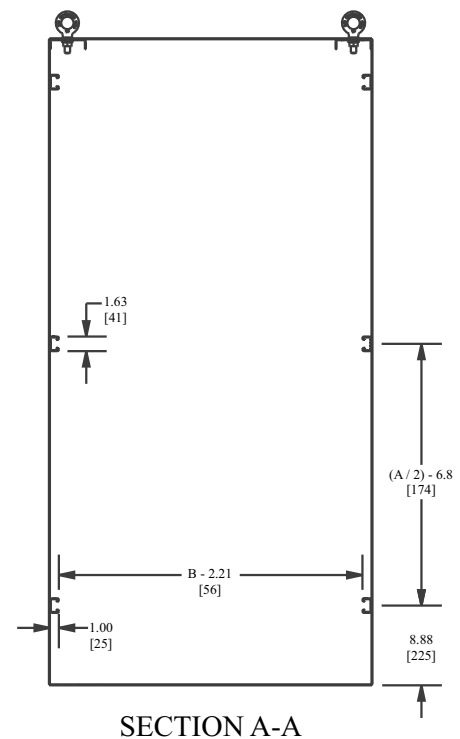
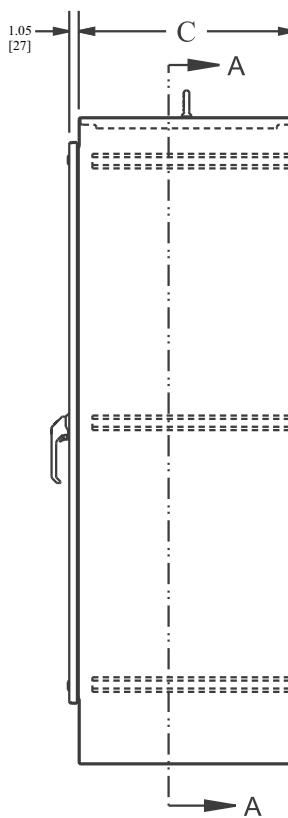
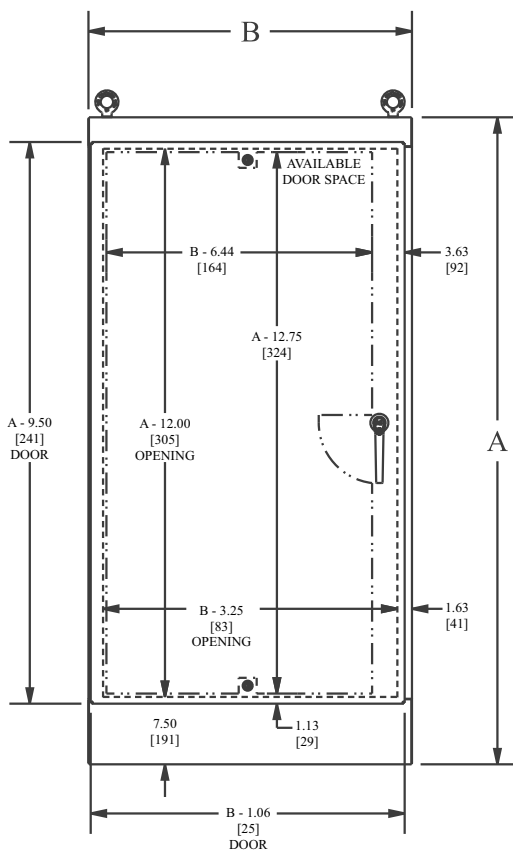

Phone (989) 799-6871  
Fax (989) 799-4524

## Free-Standing Two-Door Single Access Enclosures

### Application -

Designed to house a variety of electrical and electronic controls and instruments. Provisions for optional surface mounting or rack mounting of almost any type of equipment. Provides protection from dust, dirt, water and oil. For outdoor application a drip shield and drain holes are required. The enclosures are extra deep for applications requiring more interior space. For installation information, consult our Installation Manual at [www.saginawcontrol.com](http://www.saginawcontrol.com).

### Construction -

- 0.104" carbon steel.
- Removable and interchangeable doors.
- Concealed hinges.
- Seams continuously welded and ground smooth, no holes or knockouts.
- Strong, rigid construction with stiffeners welded on backs of single access boxes.
- Lifting eyes for easy handling.
- Black zinc die cast keylocking/padlocking handle.
- 3-point latching mechanism.
- Latch rods have ramp shoes for easier door closing.
- Flange trough collar around all sides of door opening.
- Removable print pocket on door with 3-point latch.
- Mounting channels welded horizontally on sides of interior body at top, bottom and middle for mounting optional panels or rack mounting angles.
- Hole plugs provided to seal holes in bottom of enclosure.
- Oil resistant gasket.
- Ground stud on door and body.
- Provisions for light kit.

### Finish -

ANSI-61 gray powder coated inside and out. Optional sub-panels powder coated white.

### Accessories - See page 133

#### IS3 - Industry Standards -

NEMA Type 3R, 12 & Type 13  
 UL Listed Type 3R & 12  
 CSA Type 3R & 12  
 IEC 60529 IP55

\*\*\*Special Instructions apply for IS3, IS4 and IS6 to maintain the environmental rating of Type 3R for these parts. See the Special Instructions on the Industry Standards page in the Technical Information Section.

## FREE-STANDING TWO-DOOR SINGLE ACCESS ENCLOSURES

ENCLOSURE PRODUCT CODE A2					
Catalog No.	Height (A)	Width (B)	Depth (C)	Industry Standard	List Price
SCE-604818FSD	60.00	48.00	18.00	IS3	1,717.47
SCE-724818FSD	72.00	48.00	18.00	IS3	1,891.84
SCE-724824FSD	72.00	48.00	24.00	IS3	2,049.50
SCE-726018FSD	72.00	60.00	18.00	IS3	2,128.33
SCE-726024FSD	72.00	60.00	24.00	IS3	2,302.70
SCE-726036FSD	72.00	60.00	36.00	IS3	2,649.05
SCE-727218FSD	72.00	72.00	18.00	IS3	2,364.80
SCE-727224FSD	72.00	72.00	24.00	IS3	2,555.90
SCE-904820FSD	90.00	48.00	20.00	IS3	2,214.31
SCE-904824FSD	90.00	48.00	24.00	IS3	2,302.81
SCE-907220FSD	90.00	72.00	20.00	IS3	2,792.37
SCE-907224FSD	90.00	72.00	24.00	IS3	2,933.31
SCE-907236FSD	90.00	72.00	36.00	IS3	3,360.88



Phone (989) 799-6871  
 Fax (989) 799-4524



# FREE-STANDING TWO-DOOR SINGLE ACCESS ENCLOSURES TECHNICAL DATA

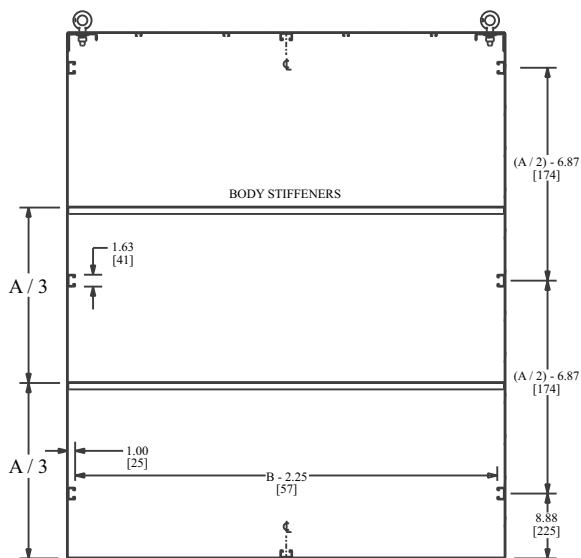
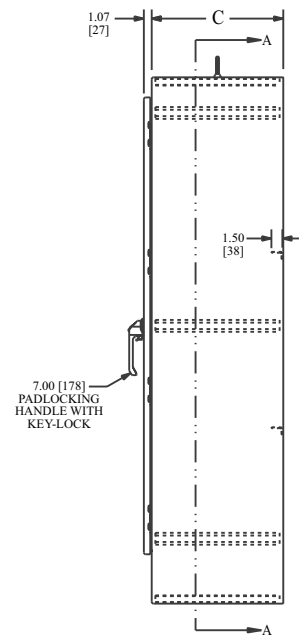
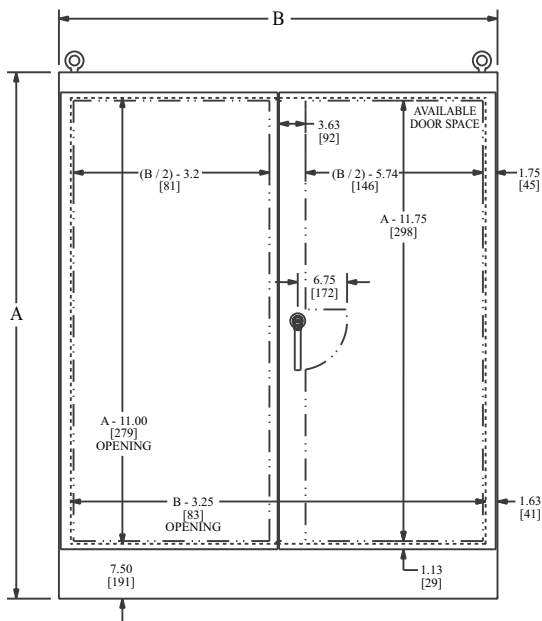
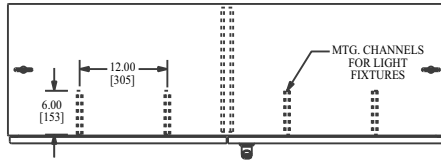

Phone (989) 799-6871  
Fax (989) 799-4524

## Enviroline® Series Free-Standing Two-Door Enclosures

### Application -

Designed to house a variety of electrical and electronic controls and instruments. Provisions for optional surface mounting or rack mounting of almost any type of equipment. Provides protection from dust, dirt, water and oil. For outdoor application a drip shield and drain holes are required. The enclosures are extra deep for applications requiring more interior space.

### Construction -

- 0.104" carbon steel.
- Removable and interchangeable doors.
- Concealed hinges.
- Seams continuously welded and ground smooth.
- Strong, rigid construction with stiffeners welded on backs of single access boxes.
- Lifting eyes for easy handling.
- Black zinc die cast keylocking/padlocking handle.
- 3-point latching mechanism.
- Latch rods have ramp shoes for easier door closing.
- Flange trough collar around all sides of door opening.
- Removable center post.
- Removable print pocket.
- Mounting channels welded horizontally on sides of interior body at top, bottom and middle for mounting optional panels or rack mounting angles.
- Hole plugs provided to seal holes in bottom of enclosure.
- Oil resistant gasket.
- Ground stud on door and body.
- Provisions for light kit.

### Finish -

ANSI-61 gray powder coated inside and out. Optional sub-panels powder coated white.

### Accessories - See page 133

### IS4 - Industry Standards -

NEMA Type 3R, 4, 12 & Type 13  
 UL Listed Type 3R, 4 & 12  
 CSA Type 3R, 4 & 12  
 IEC 60529 IP66

\*\*\*Special Instructions apply for IS3, IS4 and IS6 to maintain the environmental rating of Type 3R for these parts. See the Special Instructions on the Industry Standards page in the Technical Information Section.

## ENVIROLINE® SERIES FREE-STANDING TWO-DOOR SINGLE ACCESS ENCLOSURES

ENCLOSURE PRODUCT CODE A2					
Catalog No.	Height (A)	Width (B)	Depth (C)	Industry Standard	List Price
SCE-60EL4818FSD	60.00	48.00	18.00	IS4	2,207.05
SCE-72EL4818FSD	72.00	48.00	18.00	IS4	2,443.05
SCE-72EL4824FSD	72.00	48.00	24.00	IS4	2,601.58
SCE-72EL6018FSD	72.00	60.00	18.00	IS4	2,680.41
SCE-72EL6024FSD	72.00	60.00	24.00	IS4	2,854.78
SCE-72EL6036FSD	72.00	60.00	36.00	IS4	3,201.13
SCE-72EL7218FSD	72.00	72.00	18.00	IS4	2,937.72
SCE-72EL7224FSD	72.00	72.00	24.00	IS4	3,128.82
SCE-90EL4820FSD	90.00	48.00	20.00	IS4	2,828.89
SCE-90EL7220FSD	90.00	72.00	20.00	IS4	3,427.79
SCE-90EL7224FSD	90.00	72.00	24.00	IS4	3,568.73
SCE-90EL7236FSD	90.00	72.00	36.00	IS4	3,996.30



Phone (989) 799-6871  
 Fax (989) 799-4524



# ENVIROLINE® SERIES FREE-STANDING TWO-DOOR SINGLE ACCESS ENCLOSURES TECHNICAL DATA

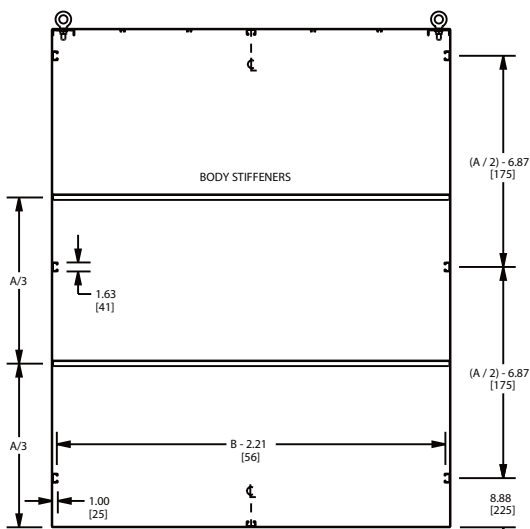
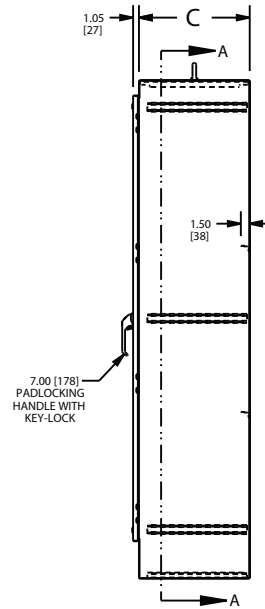
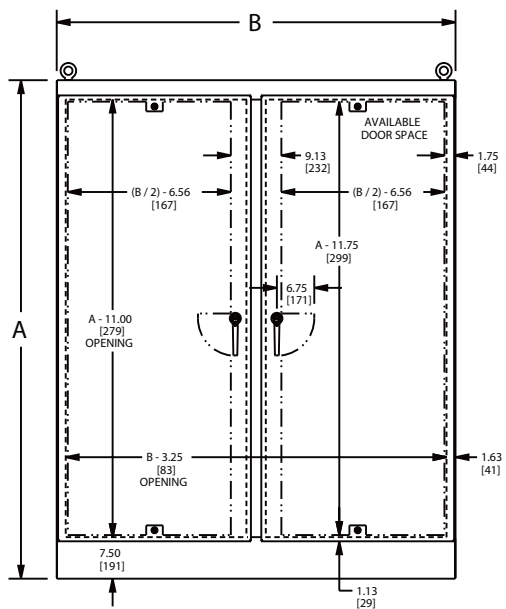
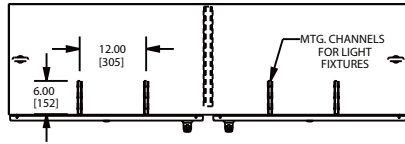

LATCH NOTE:  
OMIT CENTER LATCH TOP AND  
BOTTOM OF DOOR WHEN DOOR  
WIDTH IS  $\leq 30.00''$  [762]

SECTION A-A



Phone (989) 799-6871  
Fax (989) 799-4524

- 1 Operator System Enclosures
- 2 Wall-Mount Enclosures
- 3 Free-Standing & Floor-Mounted Enclosures
- 4 Modular Enclosures
- 5 Operator System Enclosures (Stainless Steel)
- 6 Wall-Mount Enclosures (Stainless Steel)
- 7 Free-Standing & Floor-Mounted Enclosures (Stainless Steel)
- 8 Non-Metallic Enclosures
- 9 Accessories
- 10 Technical Information
- 11 Index

## Free-Standing Single-Door Dual Access Enclosures

### Application -

Designed to house a variety of electrical and electronic controls and instruments. Provisions for optional surface mounting or rack mounting of almost any type of equipment. Provides protection from dust, dirt, water and oil. For outdoor application a drip shield and drain holes are required. The enclosures are extra deep for applications requiring more interior space. For installation information, consult our Installation Manual at www.saginawcontrol.com.

### Construction -

- 0.104" carbon steel.
- Seams continuously welded and ground smooth, no holes or knockouts.
- Strong, rigid construction.
- Lifting eyes for easy handling.
- Black zinc die cast keylocking/padlocking handle.
- 3-point latching mechanism.
- Latch rods have ramp shoes for easier door closing.
- Concealed hinges.
- Flange trough collar around all sides of door opening.
- Removable print pocket on door.
- Black quarter turn latches as required.
- Mounting channels welded horizontally on sides of interior body at top, bottom and middle for mounting optional panels or rack mounting angles.
- Hole plugs provided to seal holes in bottom of enclosure.
- Oil resistant gasket.
- Ground stud on door and body.
- Removable and interchangeable doors.
- Provisions for light kit.

### Finish -

ANSI-61 gray powder coated inside and out. Optional sub-panels powder coated white.

### Accessories - See page 134

#### IS3 - Industry Standards -

NEMA Type 3R, 12 & Type 13  
 UL Listed Type 3R & 12  
 CSA Type 3R & 12  
 IEC 60529 IP55

#### IS4 - Industry Standards -

NEMA Type 3R, 4, 12 & Type 13  
 UL Listed Type 3R, 4, & 12  
 CSA Type 3R, 4 & 12  
 IEC 60529 IP66

\*\*\*Special Instructions apply for IS3, IS4 and IS6 to maintain the environmental rating of Type 3R for these parts. See the Special Instructions on the Industry Standards page in the Technical Information Section.

## FREE-STANDING SINGLE-DOOR DUAL ACCESS ENCLOSURES

ENCLOSURE PRODUCT CODE A2					
Catalog No.	Height (A)	Width (B)	Depth (C)	Industry Standard	List Price
SCE-72EL2424FSDA	72.00	24.00	24.00	IS4	1,476.21
SCE-72EL2430FSDA	72.00	24.00	30.00	IS4	1,623.11
SCE-72EL2436FSDA	72.00	24.00	36.00	IS4	1,772.40
SCE-72EL3024FSDA	72.00	30.00	24.00	IS4	1,624.31
SCE-723624FSDA	72.00	36.00	24.00	IS3	1,772.40
SCE-723636FSDA	72.00	36.00	36.00	IS3	2,104.44
SCE-903624FSDA	90.00	36.00	24.00	IS3	2,049.50
SCE-903636FSDA	90.00	36.00	36.00	IS3	2,438.85

Part numbers that contain the letters "EL" with doors that are over 30 Inches wide have quarter turn latches on the center of the door top and bottom.



Phone (989) 799-6871  
 Fax (989) 799-4524



# FREE-STANDING SINGLE-DOOR DUAL ACCESS ENCLOSURES TECHNICAL DATA

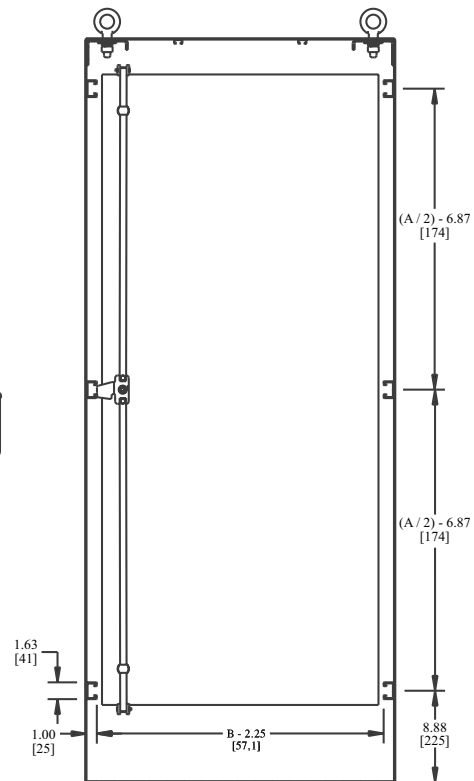
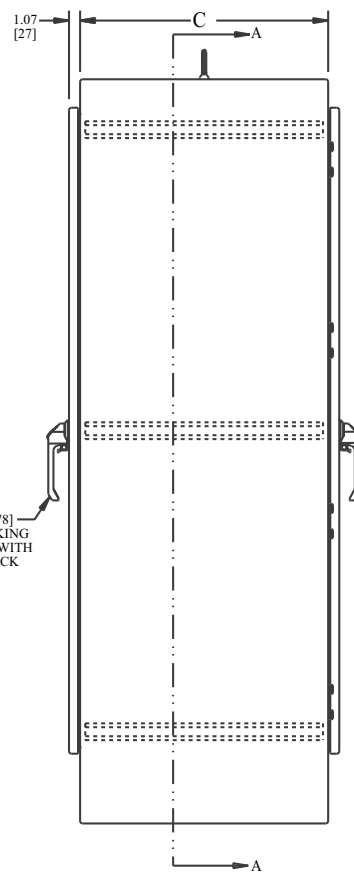
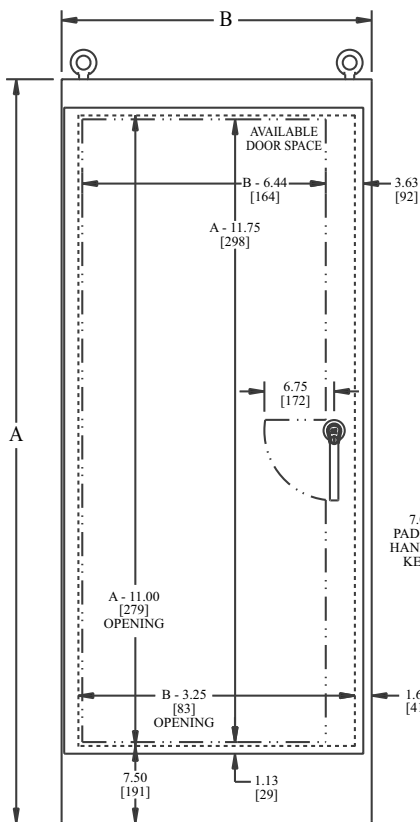
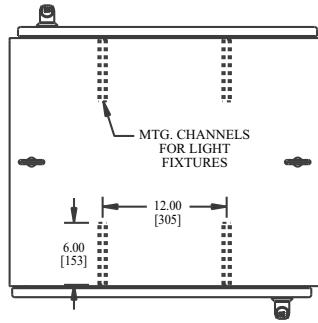

SECTION A-A



Phone (989) 799-6871  
Fax (989) 799-4524

## Free-Standing Two-Door Dual Access Enclosures

### Application -

Designed to house a variety of electrical and electronic controls and instruments. Provisions for optional surface mounting or rack mounting of almost any type of equipment. Provides protection from dust, dirt, water and oil. For outdoor application a drip shield and drain holes are required. The enclosures are extra deep for applications requiring more interior space. For installation information, consult our Installation Manual at [www.saginawcontrol.com](http://www.saginawcontrol.com).

### Construction -

- 0.104" carbon steel.
- Seams continuously welded and ground smooth, no holes or knockouts.
- Strong rigid construction.
- Lifting eyes for easy handling.
- Black zinc die cast keylocking/padlocking handle.
- 3-point latching mechanism.
- Latch rods have ramp shoes for easier door closing.
- Concealed hinges.
- Flange trough collar around all sides of door opening.
- Removable print pocket on door with 3-point latch..
- Mounting channels welded horizontally on sides of interior body at top, bottom and middle for mounting optional panels or rack mounting angles.
- Hole plugs provided to seal holes in bottom of enclosure.
- Oil resistant gasket.
- Ground stud on door and body.
- Removable and interchangeable doors.
- Provisions for light kit.

### Finish -

ANSI-61 gray powder coated inside and out. Optional sub-panels powder coated white.

### Accessories - See page 135

#### IS3 - Industry Standards -

NEMA Type 3R, 12 & Type 13  
 UL Listed Type 3R & 12  
 CSA Type 3R & 12  
 IEC 60529 IP55

\*\*\*Special Instructions apply for IS3, IS4 and IS6 to maintain the environmental rating of Type 3R for these parts. See the Special Instructions on the Industry Standards page in the Technical Information Section.

## FREE-STANDING TWO-DOOR DUAL ACCESS ENCLOSURES

ENCLOSURE PRODUCT CODE A2					
Catalog No.	Height (A)	Width (B)	Depth (C)	Industry Standard	List Price
SCE-724824FSDAD	72.00	48.00	24.00	IS3	2,551.13
SCE-726024FSDAD	72.00	60.00	24.00	IS3	2,866.42
SCE-726036FSDAD	72.00	60.00	36.00	IS3	3,298.78
SCE-727224FSDAD	72.00	72.00	24.00	IS3	3,181.73
SCE-907224FSDAD	90.00	72.00	24.00	IS3	3,653.50



Phone (989) 799-6871  
 Fax (989) 799-4524





# FREE-STANDING TWO-DOOR DUAL ACCESS ENCLOSURES TECHNICAL DATA

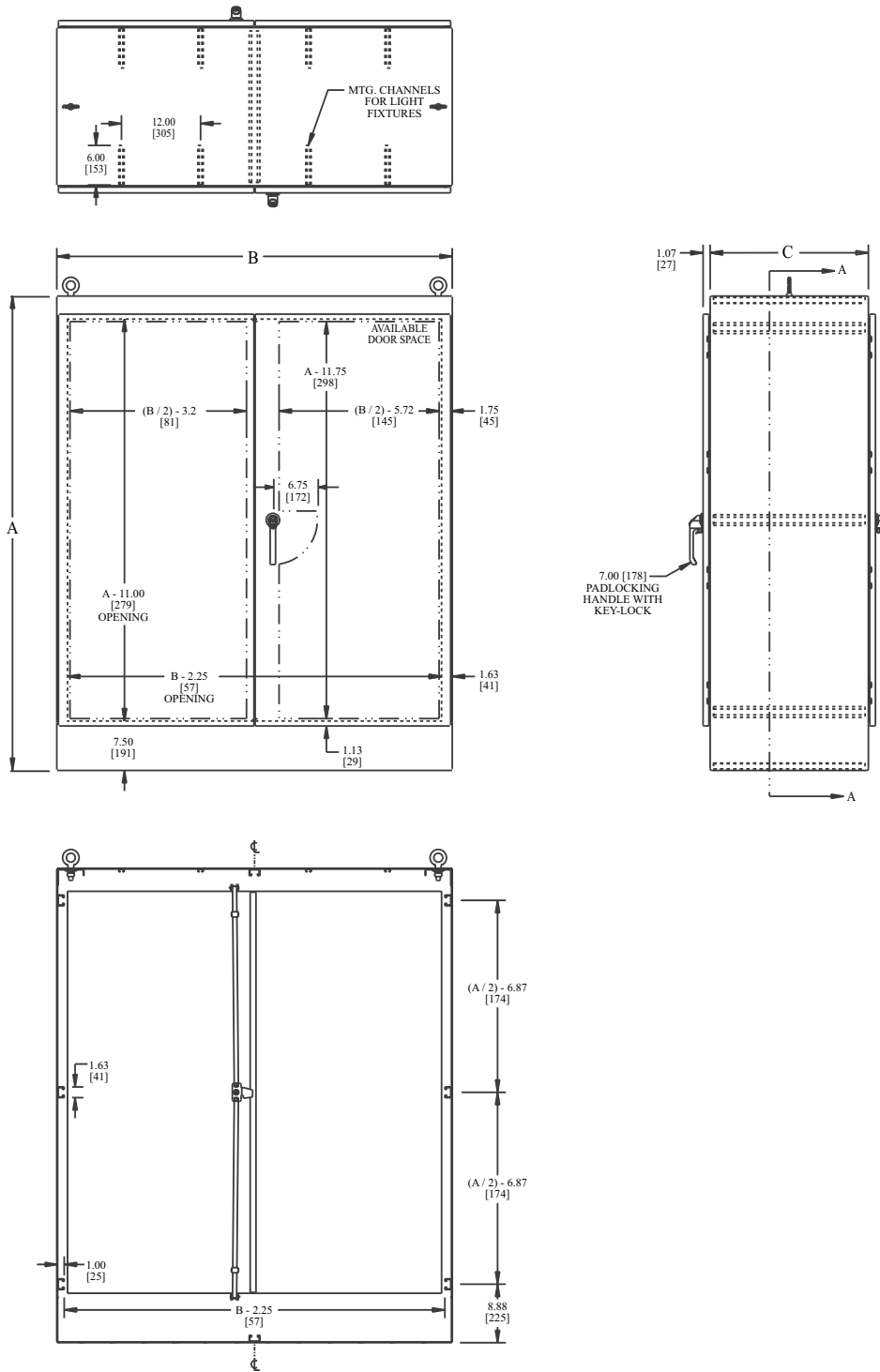

SECTION A-A



Phone (989) 799-6871  
Fax (989) 799-4524

- 1 Operator System Enclosures
- 2 Wall-Mount Enclosures
- 3 Free-Standing & Floor-Mount Enclosures
- 4 Modular Enclosures
- 5 Operator System Enclosures (Stainless Steel)
- 6 Wall-Mount Enclosures (Stainless Steel)
- 7 Free-Standing & Floor-Mount Enclosures (Stainless Steel)
- 8 Non-Metallic Enclosures
- 9 Accessories
- 10 Technical Information
- 11 Index

# SINGLE-DOOR - SINGLE ACCESS ACCESSORY SELECTION GUIDE

PART NUMBER	DESCRIPTION	SIZE	ACCESSORY SELECTION														
			SCE-60EL2418F5/SSFS	SCE-603624F5/SSFS	SCE-72EL2418F5/SSFS	SCE-72EL2424F5/SSFS	SCE-72EL3018F5/SSFS	SCE-72EL3024F5/SSFS	SCE-723618F5/SSFS	SCE-723624F5/SSFS	SCE-723630F5/SSFS	SCE-723636F5/SSFS	SCE-90EL2420F5/SSFS	SCE-903620F5/SSFS	SCE-903624F5/SSFS	SCE-903636F5/SSFS	
SCE-60P24F1	Full Panel	48.00H x 20.00W	•		A	A								A			
SCE-60P36F1	Full Panel	48.00H x 32.00W		•						A	A	A	A		A	A	A
SCE-72P24F1	Full Panel	60.00H x 20.00W			•	•								A			
SCE-72P30F1	Full Panel	60.00H x 26.00W					•	•									
SCE-72P36F1	Full Panel	60.00H x 32.00W								•	•	•	•		A	A	A
SCE-90P24F1	Full Panel	78.00H x 20.00W												•			
SCE-90P36F1	Full Panel	78.00H x 32.00W													•	•	•
SCE-60P24F2	Half Panel	24.88H x 20.00W	•		A	A								A			
SCE-60P36F2	Half Panel	24.88H x 32.00W		•						A	A	A	A		A	A	A
SCE-72P24F2	Half Panel	30.88H x 20.00W	A		•	•								A			
SCE-72P30F2	Half Panel	30.88H x 26.00W					•	•									
SCE-72P36F2	Half Panel	30.88H x 32.00W		A						•	•	•	•		A	A	A
SCE-90P24F2	Half Panel	39.88H x 20.00W	A		A	A								•			
SCE-90P36F2	Half Panel	39.88H x 32.00W		A						A	A	A	A		•	•	•
SCE-60SMP14	Side Panel	48.00H x 14.00W	•	•													
SCE-72SMP14	Side Panel	60.00H x 14.00W			•	•	•	•	•	•	•	•	•				
SCE-72SMP20	Side Panel	60.00H x 20.00W				•		•		•	•	•					
SCE-90SMP14	Side Panel	78.00H x 14.00W												•	•	•	•
SCE-90SMP20	Side Panel	78.00H x 20.00W															•
SCE-90SMP30	Side Panel	78.00H x 30.00W															•
SCE-72SP24F3	Full Swing-Out Panel	60.00H x 18.81W			•	•											
SCE-72SP30F3	Full Swing-Out Panel	60.00H x 24.81W					•	•									
SCE-72SP36F3	Full Swing-Out Panel	60.00H x 30.81W								•	•	•	•				
SCE-90SP36F3	Full Swing-Out Panel	78.00H x 30.81W												•	•	•	•
SCE-72SP24F4	Half Swing-Out Panel	30.88H x 18.81W			•	•											
SCE-72SP30F4	Half Swing-Out Panel	30.88H x 24.81W					•	•									
SCE-72SP36F4	Half Swing-Out Panel	30.88H x 30.81W								•	•	•	•				
SCE-90SP36F4	Half Swing-Out Panel	39.88H x 30.81W												•	•	•	•
SCE-7230SOF19	Swing-Out Rack Frame	60.50H x 27.56W					•	•									
SCE-7236SOF19	Swing-Out Rack Frame	60.50H x 33.56W								•	•	•	•				
SCE-9036SOF19	Swing-Out Rack Frame	78.50H x 33.56W												•	•	•	•
SCE-14RMW	Removable Wire Cover	14.00D	•		•		•		•								
SCE-20RMW	Removable Wire Cover	20.00D		•		•		•		•	•	•	•		•	•	•
SCE-60RA19TH	Type RA Rack Angle	49.00H	•		•	•								•			
SCE-72RA19TH	Type RA Rack Angle	61.25H			•	•								•			
SCE-72RA24TH	Type RA Rack Angle	61.25H					•	•									
SCE-90RA19TH	Type RA Rack Angle	78.75H												•			
SCE-60RP24F5	Type RP Full Rack Angle	49.00H	•		•	•								•			
SCE-72RP24F5	Type RP Full Rack Angle	61.25H			•	•								•			
SCE-72RP30F5	Type RP Full Rack Angle	61.25H					•	•									
SCE-90RP24F5	Type RP Full Rack Angle	78.75H												•			
SCE-60RP24F6	Type RP Half Rack Angle	26.25H	•														
SCE-72RP24F6	Type RP Half Rack Angle	31.50H	•		•	•											
SCE-72RP30F6	Type RP Half Rack Angle	31.50H					•	•									
SCE-90RP24F6	Type RP Half Rack Angle	40.25H	•		•	•								•			
SCE-60FSDPS	Heavy Duty Panel Support	57.25H	•	•													
SCE-72FSDPS	Heavy Duty Panel Support	69.25H			•	•	•	•	•	•	•	•	•				
SCE-90FSDPS	Heavy Duty Panel Support	87.25H												•	•	•	•

A - Requires heavy duty panel supports (SCE-FSHDPS\*)  
 B - Requires center panel support (SCE-FSCPS\*)  
 C - Cannot be used when other panels are installed.  
 • - Installation does not require additional supports or hardware.  
 \* - Blank space - Height of enclosure.

**SAGINAW CONTROL & ENGINEERING • STOCK PRICE LIST**

## TWO-DOOR - SINGLE ACCESS ACCESSORY SELECTION GUIDE

SCE-604818FSD/SSFSD  
SCE-724818FSD/SSFSD  
SCE-724824FSD/SSFSD  
SCE-726018FSD/SSFSD  
SCE-726024FSD/SSFSD  
SCE-726036FSD/SSFSD  
SCE-727218FSD/SSFSD  
SCE-727224FSD/SSFSD  
SCE-904820FSD/SSFSD  
SCE-904824FSD/SSFSD  
SCE-907220FSD/SSFSD  
SCE-907224FSD/SSFSD  
SCE-907236FSD/SSFSD

PART NUMBER	DESCRIPTION	SIZE	SCE-604818FSD/SSFSD	SCE-724818FSD/SSFSD	SCE-724824FSD/SSFSD	SCE-726018FSD/SSFSD	SCE-726024FSD/SSFSD	SCE-726036FSD/SSFSD	SCE-727218FSD/SSFSD	SCE-727224FSD/SSFSD	SCE-904820FSD/SSFSD	SCE-904824FSD/SSFSD	SCE-907220FSD/SSFSD	SCE-907224FSD/SSFSD	SCE-907236FSD/SSFSD
SCE-60P24F1	Full Panel	48.00H x 20.00W	B	AB	AB				AB	AB	AB	AB		AB	AB
SCE-60P36F1	Full Panel	48.00H x 32.00W													
SCE-60P48F1	Full Panel	48.00H x 44.00W	•	A	A						A	A			
SCE-72P24F1	Full Panel	60.00H x 20.00W		B	B						AB	AB			
SCE-72P30F1	Full Panel	60.00H x 26.00W				B	B	B							
SCE-72P36F1	Full Panel	60.00H x 32.00W							B	B			AB	AB	AB
SCE-72P48F1	Full Panel	60.00H x 44.00W	•	•							A	A			
SCE-72P60F1	Full Panel	60.00H x 56.00W				•	•	•							
SCE-72P72F1	Full Panel	60.00H x 68.00W							•	•			A	A	A
SCE-90P24F1	Full Panel	78.00H x 20.00W									B	B			
SCE-90P36F1	Full Panel	78.00H x 32.00W											B	B	B
SCE-90P48F1	Full Panel	78.00H x 44.00W									•	•			
SCE-90P72F1	Full Panel	78.00H x 68.00W											•	•	•
SCE-60P24F2	Half Panel	24.88H x 20.00W	B	AB	AB						AB	AB			
SCE-60P36F2	Half Panel	24.88H x 32.00W							AB	AB			AB	AB	AB
SCE-72P24F2	Half Panel	30.88H x 20.00W	AB	B	B						AB	AB			
SCE-72P30F2	Half Panel	30.88H x 26.00W				B	B	B							
SCE-72P36F2	Half Panel	30.88H x 32.00W							B	B			AB	AB	AB
SCE-72P48F2	Half Panel	30.88H x 44.00W	A	•	•						A	A			
SCE-72P60F2	Half Panel	30.88H x 56.00W				•	•	•							
SCE-72P72F2	Half Panel	30.88H x 68.00W							•	•			A	A	A
SCE-90P24F2	Half Panel	39.88H x 20.00W	AB	AB	AB						B	B			
SCE-90P36F2	Half Panel	39.88H x 32.00W							AB	AB			B	B	B
SCE-90P48F2	Half Panel	39.88H x 44.00W		A	A						•	•			
SCE-90P72F2	Half Panel	39.88H x 68.00W							A	A			•	•	•
SCE-60SMP14	Side Panel	48.00H x 14.00W	C												
SCE-72SMP14	Side Panel	60.00H x 14.00W		C	•	C	•	•	C	•					
SCE-72SMP20	Side Panel	60.00H x 20.00W			C		C	•	C						
SCE-90SMP14	Side Panel	78.00H x 14.00W									•	•	•	•	•
SCE-90SMP20	Side Panel	78.00H x 20.00W									C		C	•	
SCE-90SMP30	Side Panel	78.00H x 30.00W												•	
SCE-72SP24F3	Full Swing-Out Panel	60.00H x 18.81W	B	B											
SCE-72SP30F3	Full Swing-Out Panel	60.00H x 24.81W				B	B	B							
SCE-72SP36F3	Full Swing-Out Panel	60.00H x 30.81W							B	B					
SCE-90SP36F3	Full Swing-Out Panel	78.00H x 30.81W											B	B	B
SCE-72SP24F4	Half Swing-Out Panel	30.88H x 18.81W		B	B										
SCE-72SP30F4	Half Swing-Out Panel	30.88H x 24.81W				B	B	B							
SCE-72SP36F4	Half Swing-Out Panel	30.88H x 30.81W							B	B					
SCE-90SP36F4	Half Swing-Out Panel	39.88H x 30.81W											B	B	B
SCE-7230SOF19	Swing-Out Rack Frame	60.50H x 27.56W				B	B	B							
SCE-7236SOF19	Swing-Out Rack Frame	60.50H x 33.56W							B	B					
SCE-9036SOF19	Swing-Out Rack Frame	78.50H x 33.56W											B	B	B
SCE-14RMW	Removable Wire Cover	14.00D	•	•	•				•						
SCE-20RMW	Removable Wire Cover	20.00D			•	•	•		•	•	•	•	•	•	•
SCE-60RA19TH	Type RA Rack Angle	49.00H	B	B	B						B				
SCE-72RA19TH	Type RA Rack Angle	61.25H		B	B						B				
SCE-72RA24TH	Type RA Rack Angle	61.25H				B	B	B							
SCE-90RA19TH	Type RA Rack Angle	78.75H									B				
SCE-60RP24F5	Type RP Full Rack Angle	49.00H		B	B						B				
SCE-72RP24F5	Type RP Full Rack Angle	61.25H	B	B	B						B				
SCE-72RP30F5	Type RP Full Rack Angle	61.25H				B	B	B							
SCE-90RP24F5	Type RP Full Rack Angle	78.75H									B				
SCE-60RP24F6	Type RP Half Rack Angle	26.25H	B												
SCE-72RP24F6	Type RP Half Rack Angle	31.50H	B	B	B										
SCE-72RP30F6	Type RP Half Rack Angle	31.50H				B	B	B							
SCE-90RP24F6	Type RP Half Rack Angle	40.25H	B	B	B						B				
SCE-60FSDPS	Heavy Duty Panel Support	57.25H	B												
SCE-72FSDPS	Heavy Duty Panel Support	69.25H		B	B	B	B	B	B	B					
SCE-90FSDPS	Heavy Duty Panel Support	87.25H									B	B	B	B	B
SCE-60FSCPS	Center Panel Support	56.00H	•												
SCE-72FSCPS	Center Panel Support	68.00H		•	•	•	•	•	•	•					
SCE-90FSCPS	Center Panel Support	86.00H									•	•	•	•	•
SCE-72FSCS	Center Support	69.50H		•	•	•	•	•	•	•					
SCE-90FSCS	Center Support	87.50H									•	•	•	•	•

1 Operator System Enclosures  
 2 Wall-Mount Enclosures  
 3 Free-Standing & Floor-Mounted Enclosures  
 4 Modular Enclosures  
 5 Operator System Enclosures (Stainless Steel)  
 6 Wall-Mount Enclosures (Stainless Steel)  
 7 Free-Standing & Floor-Mounted Enclosures (Stainless Steel)  
 8 Non-Metallic Enclosures  
 9 Accessories  
 10 Technical Information  
 11 Index

# SINGLE-DOOR - DUAL ACCESS ACCESSORY SELECTION GUIDE

PART NUMBER	DESCRIPTION	SIZE									
			SCE-72EL2424FSDA/SSFSDA	SCE-72EL2430FSDA/SSFSDA	SCE-72EL2436FSDA/SSFSDA	SCE-72EL3024FSDA/SSFSDA	SCE-723624FSDA/SSFSDA	SCE-723636FSDA/SSFSDA	SCE-903624FSDA/SSFSDA	SCE-903636FSDA/SSFSDA	
SCE-60P24F1	Full Panel	48.00H x 20.00W	A	A	A						
SCE-60P36F1	Full Panel	48.00H x 32.00W					A	A	A	A	
SCE-72P24F1	Full Panel	60.00H x 20.00W	•	•	•						
SCE-72P30F1	Full Panel	60.00H x 26.00W				•					
SCE-72P36F1	Full Panel	60.00H x 32.00W					•	•	A	A	
SCE-90P36F1	Full Panel	78.00H x 32.00W							•	•	
SCE-60P24F2	Half Panel	24.88H x 20.00W	A	A	A						
SCE-60P36F2	Half Panel	24.88H x 32.00W					A	A	A	A	
SCE-72P24F2	Half Panel	30.88H x 20.00W	•	•	•						
SCE-72P30F2	Half Panel	30.88H x 26.00W				•					
SCE-72P36F2	Half Panel	30.88H x 32.00W					•	•	A	A	
SCE-90P24F2	Half Panel	39.88H x 20.00W	A	A	A						
SCE-90P36F2	Half Panel	39.88H x 32.00W					A	A	•	•	
SCE-72SMP14	Side Panel	60.00H x 14.00W	•	•	•	•	•	•			
SCE-72SMP20	Side Panel	60.00H x 20.00W	•	•	•	•	•	•			
SCE-90SMP14	Side Panel	78.00H x 14.00W							•	•	
SCE-90SMP20	Side Panel	78.00H x 20.00W							•	•	
SCE-90SMP30	Side Panel	78.00H x 30.00W								•	
SCE-72SP24F3	Full Swing-Out Panel	60.00H x 18.81W	•	•	•						
SCE-72SP30F3	Full Swing-Out Panel	60.00H x 24.81W				•					
SCE-72SP36F3	Full Swing-Out Panel	60.00H x 30.81W					•	•			
SCE-90SP36F3	Full Swing-Out Panel	78.00H x 30.81W							•	•	
SCE-72SP24F4	Half Swing-Out Panel	30.88H x 18.81W	•	•	•						
SCE-72SP30F4	Half Swing-Out Panel	30.88H x 24.81W				•					
SCE-72SP36F4	Half Swing-Out Panel	30.88H x 30.81W					•	•			
SCE-90SP36F4	Half Swing-Out Panel	30.88H x 30.81W							•	•	
SCE-7230SOF19	Swing-Out Rack Frame	60.50H x 27.56W				•					
SCE-7236SOF19	Swing-Out Rack Frame	60.50H x 33.56W					•	•			
SCE-9036SOF19	Swing-Out Rack Frame	78.50H x 33.56W							•	•	
SCE-20RMW	Removable Wire Cover	20.00D	•	•	•	•	•	•	•	•	•
SCE-60RA19TH	Type RA Rack Angle	49.00H	•	•	•						
SCE-72RA19TH	Type RA Rack Angle	61.25H	•	•	•						
SCE-72RA24TH	Type RA Rack Angle	61.25H				•					
SCE-60RP24F5	Type RP Full Rack Angle	49.00H	•	•	•						
SCE-72RP24F5	Type RP Full Rack Angle	61.25H	•	•	•						
SCE-72RP30F5	Type RP Full Rack Angle	61.25H				•					
SCE-72RP24F6	Type RP Half Rack Angle	31.50H	•	•	•						
SCE-72RP30F6	Type RP Half Rack Angle	31.50H				•					
SCE-90RP24F6	Type RP Half Rack Angle	40.25H	•	•	•						
SCE-72FSHDPS	Heavy Duty Panel Support	69.25H	•	•	•	•	•	•			
SCE-90FSHDPS	Heavy Duty Panel Support	87.25H							•	•	

• - Installation does not require additional supports or hardware.  
 A - Requires heavy duty panel supports (SCE-FSHDPS\*)  
 B - Requires center panel support (SCE-FSCPS\*)  
 C - Cannot be used when other panels are installed.  
 \* Blank space - Height of enclosure.

Phone (989) 799-6871  
 Fax (989) 799-4524



1 Operator System Enclosures  
 2 Wall-Mount Enclosures  
 3 Free-Standing & Floor-Mounted Enclosures  
 4 Modular Enclosures  
 5 Operator System Enclosures (Stainless Steel)  
 6 Wall-Mount Enclosures (Stainless Steel)  
 7 Free-Standing & Floor-Mounted Enclosures (Stainless Steel)  
 8 Non-Metallic Enclosures  
 9 Accessories  
 10 Technical Information  
 11 Index

## TWO-DOOR - DUAL ACCESS ACCESSORY SELECTION GUIDE

PART NUMBER	DESCRIPTION	SIZE	SCE-724824 FSDAD/SSFSDAD					SCE-726024 FSDAD/SSFSDAD		SCE-726036 FSDAD/SSFSDAD		SCE-727224 FSDAD/SSFSDAD		SCE-907224 FSDAD/SSFSDAD	
			AB	A	B	B	B	B	AB	AB	•	•	•	•	•
SCE-60P24F1	Full Panel	48.00H x 20.00W	AB												
SCE-60P36F1	Full Panel	48.00H x 32.00W							AB	AB					
SCE-60P48F1	Full Panel	48.00H x 44.00W	A												
SCE-72P24F1	Full Panel	60.00H x 20.00W	B												
SCE-72P30F1	Full Panel	60.00H x 26.00W			B	B									
SCE-72P36F1	Full Panel	60.00H x 32.00W							B	AB					
SCE-72P48F1	Full Panel	60.00H x 44.00W	•												
SCE-72P60F1	Full Panel	60.00H x 56.00W			•	•									
SCE-72P72F1	Full Panel	60.00H x 68.00W							•	B					
SCE-90P36F1	Full Panel	78.00H x 32.00W												B	
SCE-90P72F1	Full Panel	78.00H x 68.00W												•	
SCE-60P24F2	Half Panel	24.88H x 20.00W	AB												
SCE-60P36F2	Half Panel	24.88H x 32.00W							AB	AB					
SCE-72P24F2	Half Panel	30.88H x 20.00W	B												
SCE-72P30F2	Half Panel	30.88H x 26.00W			B	B									
SCE-72P36F2	Half Panel	30.88H x 32.00W							B	AB					
SCE-72P48F2	Half Panel	30.88H x 44.00W	•												
SCE-72P60F2	Half Panel	30.88H x 56.00W			•	•									
SCE-72P72F2	Half Panel	30.88H x 68.00W							•	B					
SCE-90P24F2	Half Panel	39.88H x 20.00W	AB												
SCE-90P36F2	Half Panel	39.88H x 32.00W							AB	B					
SCE-90P48F2	Half Panel	39.88H x 44.00W	A												
SCE-90P72F2	Half Panel	39.88H x 68.00W							A	•					
SCE-72SMP14	Side Panel	60.00H x 14.00W	•	•	•	•	•	•	•	•	•	•	•	•	•
SCE-72SMP20	Side Panel	60.00H x 20.00W	•	•	•	•	•	•	•	•	•	•	•	•	•
SCE-90SMP14	Side Panel	78.00H x 14.00W												•	•
SCE-90SMP20	Side Panel	78.00H x 20.00W												•	•
SCE-72SP24F3	Full Swing-Out Panel	60.00H x 18.81W	B												
SCE-72SP30F3	Full Swing-Out Panel	60.00H x 24.81W			B	B									
SCE-72SP36F3	Full Swing-Out Panel	60.00H x 30.81W							B						
SCE-90SP36F3	Full Swing-Out Panel	78.00H x 30.81W												B	
SCE-72SP24F4	Half Swing-Out Panel	30.88H x 18.81W	B												
SCE-72SP30F4	Half Swing-Out Panel	30.88H x 24.81W			B	B									
SCE-72SP36F4	Half Swing-Out Panel	30.88H x 30.81W							B						
SCE-90SP36F4	Half Swing-Out Panel	39.88H x 30.81W												B	
SCE-7230SOF19	Swing-Out Rack Frame	60.50H x 27.56W			B	B									
SCE-7236SOF19	Swing-Out Rack Frame	60.50H x 33.56W							B						
SCE-9036SOF19	Swing-Out Rack Frame	78.50H x 33.56W												B	
SCE-20RMW	Removable Wire Cover	20.00D	•	•	•	•	•	•	•	•	•	•	•	•	•
SCE-72RA19TH	Type RA Rack Angle	61.25H	B												
SCE-72RA24TH	Type RA Rack Angle	61.25H			B	B									
SCE-72RP24F5	Type RP Full Rack Angle	61.25H	B												
SCE-72RP30F5	Type RP Full Rack Angle	61.25H			B	B									
SCE-72RP24F6	Type RP Half Rack Angle	31.50H	B												
SCE-72RP30F6	Type RP Half Rack Angle	31.50H			B	B									
SCE-90RP24F6	Type RP Half Rack Angle	40.25H	B												
SCE-72FSDPS	Heavy Duty Panel Support	69.25H	B	B	B	B	B	B							
SCE-90FSDPS	Heavy Duty Panel Support	87.25H												B	
SCE-72FSCPS	Center Panel Support	68.00H	•	•	•	•	•	•	•	•	•	•	•	•	•
SCE-90FSCPS	Center Panel Support	86.00H												•	
SCE-72FSCS	Center Support	69.50H	•	•	•	•	•	•	•	•	•	•	•	•	•
SCE-90FSCS	Center Support	87.50H												•	

## FREE-STANDING ENCLOSURE ACCESSORIES

### Panels (Full & Half Length) For Single-Door Enclosures

Panels for single-door enclosures can be positioned anywhere along the horizontal mounting channels. Half-length panels can be located in the upper or lower portion of the enclosure. Mounting hardware is included. Made of heavy gauge steel and powder coated white. GALV panels made of galvanized steel.

### Panels (Full & Half Length) For Two-Door Enclosures

Panels for two-door enclosures can be positioned anywhere along the horizontal mounting channels. Half-length panels can be located in the upper or lower portion of the enclosure. Mounting hardware is included. Made of heavy gauge steel and powder coated white. GALV panels made of galvanized steel.

### Side Mount Panels

Designed to provide extra mounting space on the side of an enclosure. Can be securely attached to the mounting channels. Plated mounting hardware is supplied. Bent on vertical sides. Made of heavy gauge steel and powder coated white.

Catalog No.	Panel Height	Panel Width	Enclosure Height	Enclosure Width	Product Code	List Price
<b>Full Panel</b>						
SCE-60P24F1	48.00	20.00	60.00	24.00	P3	173.85
SCE-60P36F1	48.00	32.00	60.00	36.00	P3	226.00
SCE-72P24F1	60.00	20.00	72.00	24.00	P3	196.20
SCE-72P30F1	60.00	26.00	72.00	30.00	P3	228.49
SCE-72P36F1	60.00	32.00	72.00	36.00	P3	258.29
SCE-90P24F1	78.00	20.00	90.00	24.00	P3	228.49
SCE-90P36F1	78.00	32.00	90.00	36.00	P3	310.45
SCE-72P30F1GALV	60.00	26.00	72.00	30.00	P3	260.11
SCE-72P36F1GALV	60.00	32.00	72.00	36.00	P3	303.77

Catalog No.	Panel Height	Panel Width	Enclosure Height	Enclosure Width	Product Code	List Price
<b>Half Panel</b>						
SCE-60P24F2	24.88	20.00	60.00	24.00	P3	116.72
SCE-60P36F2	24.88	32.00	60.00	36.00	P3	141.56
SCE-72P24F2	30.88	20.00	72.00	24.00	P3	126.66
SCE-72P30F2	30.88	26.00	72.00	30.00	P3	141.56
SCE-72P36F2	30.88	32.00	72.00	36.00	P3	158.95
SCE-90P24F2	39.88	20.00	90.00	24.00	P3	141.56
SCE-90P36F2	39.88	32.00	90.00	36.00	P3	183.79

Catalog No.	Panel Height	Panel Width	Enclosure Height	Enclosure Width	Product Code	List Price
<b>Full Panel</b>						
SCE-60P48F1	48.00	44.00	60.00	48.00	P3	362.60
SCE-72P48F1	60.00	44.00	72.00	48.00	P3	409.79
SCE-72P60F1	60.00	56.00	72.00	60.00	P3	474.36
SCE-72P72F1	60.00	68.00	72.00	72.00	P3	541.42
SCE-90P48F1	78.00	44.00	90.00	48.00	P3	481.82
SCE-90P72F1	78.00	68.00	90.00	72.00	P3	650.69
SCE-72P60F1GALV	60.00	56.00	72.00	60.00	P3	532.07
SCE-72P72F1GALV	60.00	68.00	72.00	72.00	P3	612.37
SCE-90P72F1GALV	78.00	68.00	90.00	72.00	P3	790.56

Catalog No.	Panel Height	Panel Width	Enclosure Height	Enclosure Width	Product Code	List Price
<b>Half Panel</b>						
SCE-72P48F2	30.88	44.00	72.00	48.00	P3	260.78
SCE-72P60F2	30.88	56.00	72.00	60.00	P3	295.55
SCE-72P72F2	30.88	68.00	72.00	72.00	P3	327.83
SCE-90P48F2	39.88	44.00	90.00	48.00	P3	298.03
SCE-90P72F2	39.88	68.00	90.00	72.00	P3	384.95

Catalog No.	Panel Height	Panel Width	Enclosure Height	Enclosure Width	Product Code	List Price
SCE-60SMP14	48.00	14.00	60.00	18.00	P3	138.74
SCE-72SMP14	60.00	14.00	72.00	18.00	P3	155.72
SCE-72SMP20	60.00	20.00	72.00	24.00	P3	192.53
SCE-90SMP14	78.00	14.00	90.00	18.00	P3	226.51
SCE-90SMP20	78.00	20.00	90.00	24.00	P3	235.00
SCE-90SMP30	78.00	30.00	90.00	36.00	P3	254.81

Phone (989) 799-6871  
 Fax (989) 799-4524



Catalog No.	Panel Height	Panel Width	Enclosure Height	Enclosure Width	Product Code	List Price
<b>Full Panel</b>						
SCE-72SP24F3	60.00	18.81	72.00	24.00	P2	392.41
SCE-72SP30F3	60.00	24.81	72.00	30.00	P2	454.50
SCE-72SP36F3	60.00	30.81	72.00	36.00	P2	516.59
SCE-90SP36F3	78.00	30.81	90.00	36.00	P2	613.44
<b>Half Panel</b>						
SCE-72SP24F4	30.88	18.81	72.00	24.00	P3	279.03
SCE-72SP30F4	30.88	24.81	72.00	30.00	P2	300.51
SCE-72SP36F4	30.88	30.81	72.00	36.00	P2	335.28
SCE-90SP36F4	39.88	30.81	90.00	36.00	P2	387.44



Catalog No.	Notes	Product Code	List Price
SCE-FSPS4	Set of 4	P2	55.88
SCE-FSPS6	Set of 6	P2	84.44
SCE-FSPS8	Set of 8	P2	126.66

Catalog No.	No. of Units	Enclosure Height	Enclosure Width	Product Code	List Price
SCE-7230SOF19	33	72.00	30.00	P2	389.92
SCE-7236SOF19	33	72.00	36.00	P2	419.73
SCE-9036SOF19	43	90.00	36.00	P2	442.08

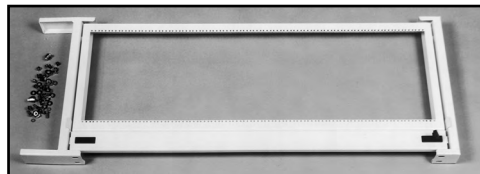

Catalog No.	Height (A)	Width (B)	Depth (C)	Enclosure Depth	Product Code	List Price
SCE-14RMW	6.00	35.00	14.00	18.00	P2	198.69
SCE-20RMW	6.00	35.00	20.00	24.00	P2	223.52

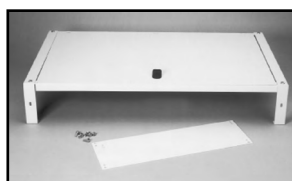

## FREE-STANDING ENCLOSURE ACCESSORIES

### Swing-Out Panels

Panels are available full length and half length and can be mounted on either side of the enclosure. Panels have heavy gauge steel support frames and concealed hinges to allow the panel to swing completely out of the enclosure. Mounting hardware is included. Made of heavy gauge steel and powder coated white. For technical information, consult our Installation Manual at [www.saginawcontrol.com](http://www.saginawcontrol.com).

### Individual Panel Supports

Individual panel supports are available for additional equipment mounting. All mounting hardware included. Made of heavy gauge steel and plated.

### Swing-Out Rack Mounting Frames

Designed for mounting 19.00" rack-mounting equipment. The frame pivots within the enclosure for access to the back of the mounted equipment. A nylon bearing allows easy movement. Quick release latches hold the frame closed. One clip nut package (CN1032) is included. Made of heavy gauge steel and powder coated white. For technical information, consult our Installation Manual at [www.saginawcontrol.com](http://www.saginawcontrol.com).

### Removable Wire Cover

Designed to cover the wires in the bottom of the enclosure. One wire cover required per door. Mounting hardware is included. Made of heavy gauge steel and powder coated white.



Phone (989) 799-6871  
Fax (989) 799-4524

## FREE-STANDING ENCLOSURE ACCESSORIES

### Rack Mounting Angle (Type RA) - "U Shape"

Designed for mounting 19 inch and 24 inch rack mount equipment. Available in pairs of full length angles with mounting holes. Use clip nut package (CN1032) to provide tapped holes. Mounting hardware is supplied. Made of heavy gauge steel and powder coated white.

### Rack Mounting Angle (Type RP) - "L Shape"

Designed for mounting 19 inch and 24 inch rack mount equipment. Available in pairs of full length angles with mounting holes. Use clip nut package (CN1032) to provide tapped holes. Mounting hardware is supplied. Made of heavy gauge steel and powder coated white.

### Rack Filler Panel

Made of heavy gauge steel with black textured powder coat finish.

### Clamping Nuts

Clamping nuts with a #10-32 retained nut will fit all rack mounting angles and rack mounting frames, to provide tapped holes. Nuts are zinc plated.

### Channel Nuts

Designed for use in free-standing enclosures to allow mounting of additional equipment. Nuts are zinc plated.

### Channel Nut Kit

Designed for use with the light channels on the inside top of SCE larger enclosures to allow easy installation of lights. Nuts are zinc plated.

Catalog No.	Angle Length	Enclosure Height	Enclosure Width	Rack Size	Product Code	List Price
SCE-60RA19TH	49.00	60.00	24.00	19	P2	106.80
SCE-72RA19TH	61.25	72.00	24.00	19	P2	114.24
SCE-72RA24TH	61.25	72.00	30.00	24	P2	114.24
SCE-90RA19TH	78.75	90.00	24.00	19	P2	124.18

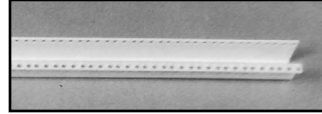

Catalog No.	Angle Length	Enclosure Height	Enclosure Width	Length	Rack Size	Product Code	List Price
SCE-60RP24F5	49.00	60.00	24.00	Full	19	P2	106.80
SCE-72RP24F5	61.25	72.00	24.00	Full	19	P2	124.18
SCE-72RP30F5	61.25	72.00	30.00	Full	24	P2	124.18
SCE-90RP24F5	78.75	90.00	24.00	Full	19	P2	166.40
SCE-60RP24F6	26.25	60.00	24.00	Half	19	P2	62.09
SCE-72RP24F6	31.50	72.00	24.00	Half	19	P2	76.99
SCE-72RP30F6	31.50	72.00	30.00	Half	24	P2	76.99
SCE-90RP24F6	40.25	90.00	24.00	Half	19	P2	94.38

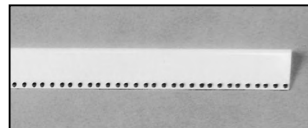

Catalog No.	Height	Width	Product Code	List Price
SCE-19-1U	1.75	19.00	P2	9.32
SCE-19-2U	3.50	19.00	P2	15.52
SCE-19-3U	5.25	19.00	P2	21.71

Catalog No.	Quantity Per Kit	Product Code	List Price
SCE-CN1032	20	P2	32.31

Catalog No.	Description	Quantity Per Kit	Product Code	List Price
SCE-PS1420CN	1/4 - 20 Strut Nut	20	P2	42.22
SCE-PS3816CN	3/8 - 16 Strut Nut	20	P2	42.22

Catalog No.	Description	Quantity Per Kit	Product Code	List Price
SCE-PS1032CN	10-32 Channel Nut	20	P2	36.02

Phone (989) 799-6871  
 Fax (989) 799-4524





## HEAVY-DUTY PANEL SUPPORTS

Catalog No.	Enclosure Height	Support Length	Product Code	List Price
SCE-60FSHDPS	60.00	57.25	P2	114.24
SCE-72FSHDPS	72.00	69.25	P2	124.18
SCE-90FSHDPS	90.00	87.25	P2	136.60

## CENTER PANEL SUPPORTS

Catalog No.	Enclosure Height	Product Code	List Price
SCE-60FSCPS	60.00	P2	119.22
SCE-72FSCPS	72.00	P2	131.63
SCE-90FSCPS	90.00	P2	156.47

## CENTER SUPPORTS

Catalog No.	Enclosure Height	Product Code	List Price
SCE-72FSCS	72.00	P2	131.63
SCE-90FSCS	90.00	P2	156.47



Heavy-Duty Panel Supports



Center Panel Supports



Center Supports

## FREE-STANDING ENCLOSURE ACCESSORIES

### Heavy-Duty Panel Supports

Available in pairs to mount panels when heavy equipment is installed on the panels. Panel mounting studs are adjustable so a panel of any height can be mounted. Used in place of individual supports. Mounting hardware furnished with enclosures. Made of heavy gauge steel and powder coated white. For technical information consult our Installation Manual at [www.saginawcontrol.com](http://www.saginawcontrol.com).

### Center Panel Supports

Designed to be installed in any two-door single access or dual access free-standing enclosure. For installation of panels, swing-out panels, rack mounting angles, and swing-out rack mounting frames. The center panel support can be positioned from front to back in the enclosure. Plated mounting hardware is supplied. Made of heavy gauge steel and powder coated white. For technical information consult our Installation Manual at [www.saginawcontrol.com](http://www.saginawcontrol.com).

### Center Supports

Designed to attach to the top and bottom mounting channels of the enclosure. Provides support for full and half panels in any free-standing two-door enclosure. Can be positioned from front to back in the enclosure. Can be used with heavy duty panel supports to use panels of various heights. Mounting hardware is included. Made of heavy gauge steel and powder coated white.



Phone (989) 799-6871  
Fax (989) 799-4524

## Multi-Door Enclosures

### Application -

Designed to house electrical equipment and provide degree of protection from dirt, dust, oil and water. For installation information, consult our Installation Manual at [www.saginawcontrol.com](http://www.saginawcontrol.com).

### Construction -

- 0.125" carbon steel.
- Seams continuously welded and ground smooth.
- Heavy duty lifting eyes.
- Reinforced top.
- Steel stiffeners welded to back inside of enclosure.
- Overlapping two-door openings have no center post.
- Black zinc die cast padlocking handle.
- 3-point latching mechanism.
- Concealed hinges.
- Mechanical interlock.
- Far right hand door is main door.
- Panel supports.
- Removable sub-panels are mounted on collar studs.
- Oil-resistant door gasket.
- Ground stud on door and body.
- Removable print pocket.
- Flange trough collar around all sides of door opening.
- Hole plugs provided to seal holes in bottom of enclosure.
- Provisions for light kit.

### Finish -

ANSI-61 gray powder coated inside and out. Sub-panels powder coated white.

### IS3 - Industry Standards -

NEMA Type 3R, 12 & Type 13  
 UL Listed Type 3R & 12  
 CSA Type 3R & 12  
 IEC 60529 IP55

\*\*\*Special Instructions apply for IS3, IS4 and IS6 to maintain the environmental rating of Type 3R for these parts. See the Special Instructions on the Industry Standards page in the Technical Information Section.

## MULTI-DOOR ENCLOSURES

ENCLOSURE PRODUCT CODE A2						SUB-PANEL (P3)			
Catalog No.	Height (A)	Width (B)	Depth (C)	Industry Standard	List Price	Catalog No.	Panel Height (D)	Panel Width (E)	List Price
SCE-86M3E	86.00	112.00	14.00	IS3	5,160.24	SCE-82P76* & SCE-82P37*	78.00	72.00	1,276.51
SCE-86M3E20	86.00	112.00	20.00	IS3	5,701.76	SCE-82P76* & SCE-82P37*	78.00	72.00	1,276.51
SCE-86M4E	86.00	149.19	14.00	IS3	6,599.08	SCE-82P76* (2)	78.00	72.00	1,601.62
SCE-86M4E20	86.00	149.19	20.00	IS3	7,523.88	SCE-82P76* (2)	78.00	72.00	1,601.62
SCE-86M5E	86.00	187.00	14.00	IS3	8,416.60	SCE-82P76* (2) & SCE-82P37*	78.00	72.00	1,276.51
SCE-86M5E20	86.00	187.00	20.00	IS3	9,294.37	SCE-82P76* (2) & SCE-82P37*	78.00	72.00	1,276.51

\*\*Sub-panel included with enclosure. Replacement sub-panels can be ordered. Prices found in the accessory section.

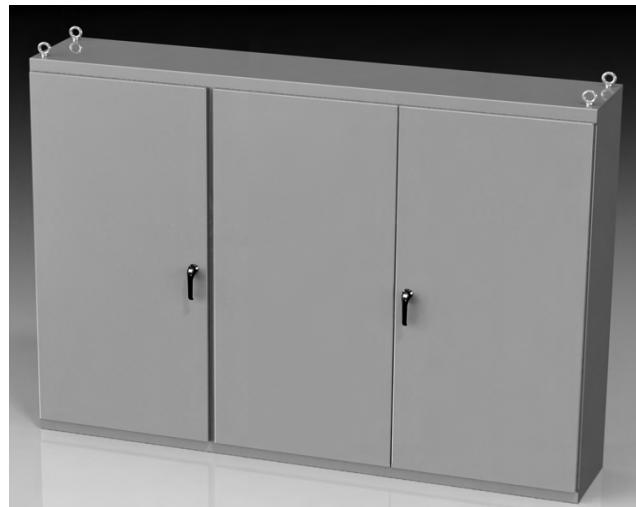

Phone (989) 799-6871  
 Fax (989) 799-4524



# MULTI-DOOR ENCLOSURES TECHNICAL DATA

## THREE-DOOR ENCLOSURE

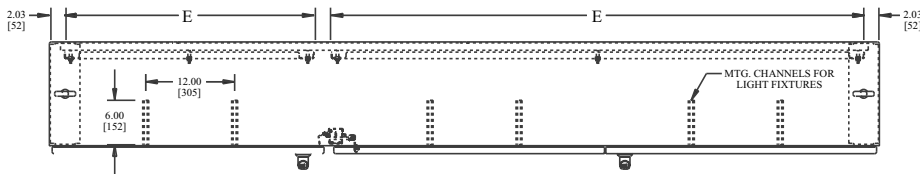

**EYEBOLT NOTES:**  
Enclosure has one row of eyebolts when C = 14.00" [356]  
Enclosure has two rows of eyebolts when C = 20.00" [508]

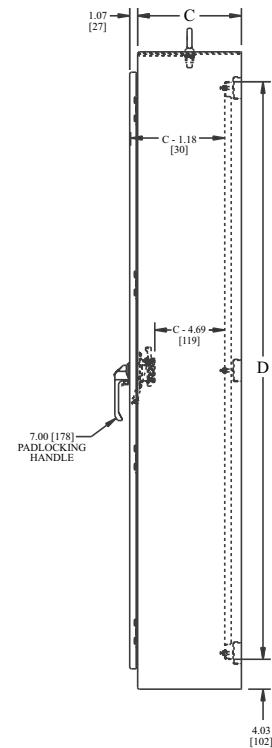
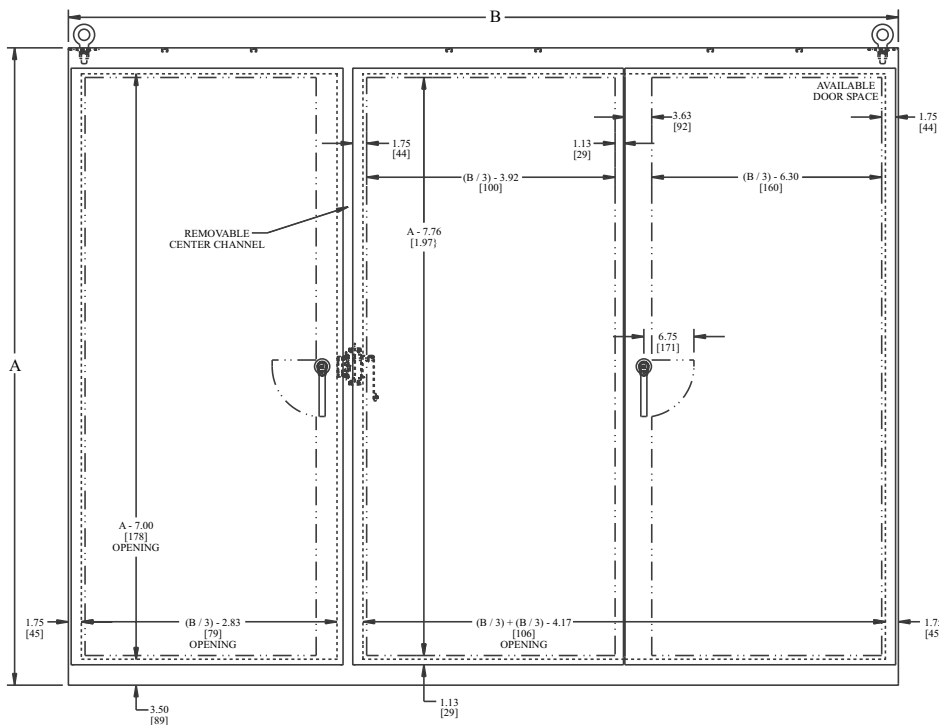

Phone (989) 799-6871  
Fax (989) 799-4524

# MULTI-DOOR ENCLOSURES TECHNICAL DATA

## FOUR-DOOR ENCLOSURE

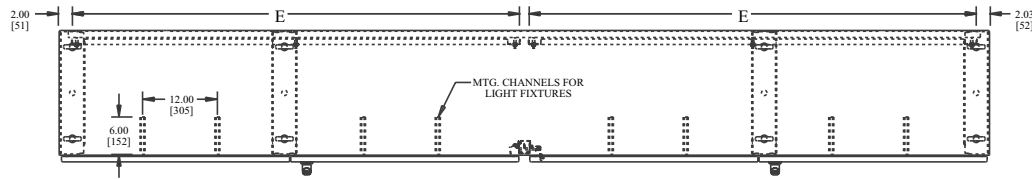

**EYEBOLT NOTES:**

Enclosure has one row of eyebolts when  $C = 14.00$ " [356]  
 Enclosure has two rows of eyebolts when  $C = 20.00$ " [508]

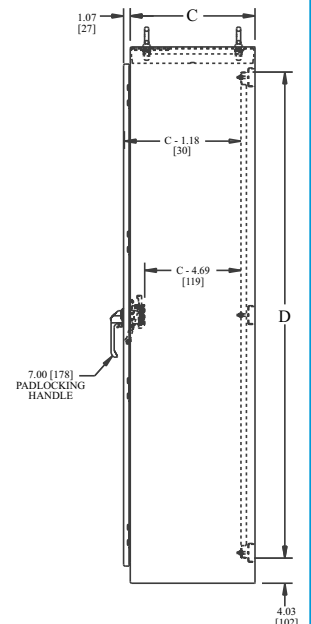
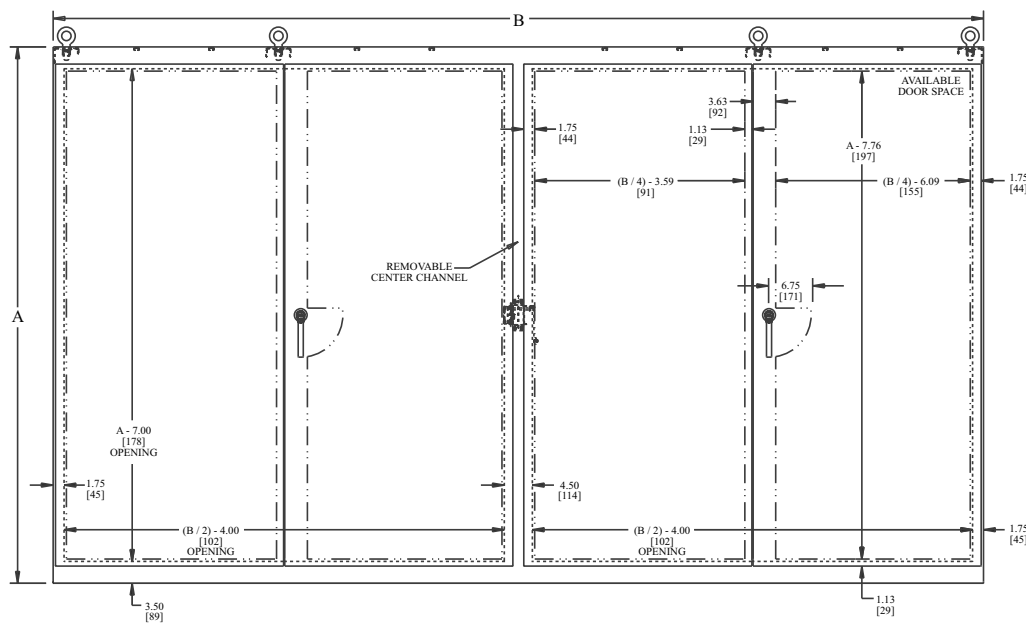

Phone (989) 799-6871  
 Fax (989) 799-4524



# MULTI-DOOR ENCLOSURES TECHNICAL DATA

## FIVE-DOOR ENCLOSURE

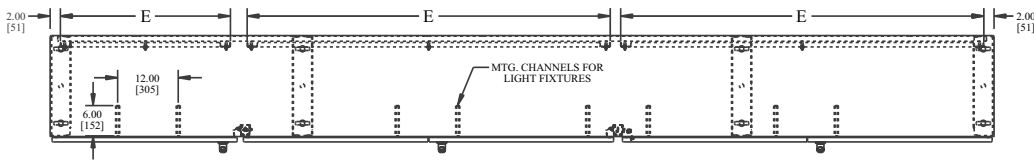

**EYEBOLT NOTES:**  
Enclosure has one row of eyebolts when C = 14.00" [356]  
Enclosure has two rows of eyebolts when C = 20.00" [508]

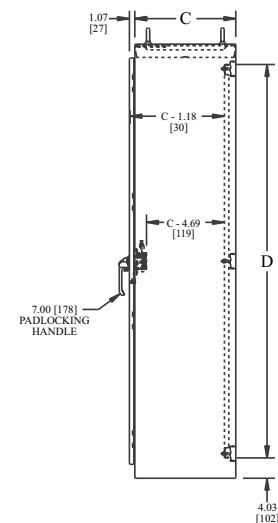
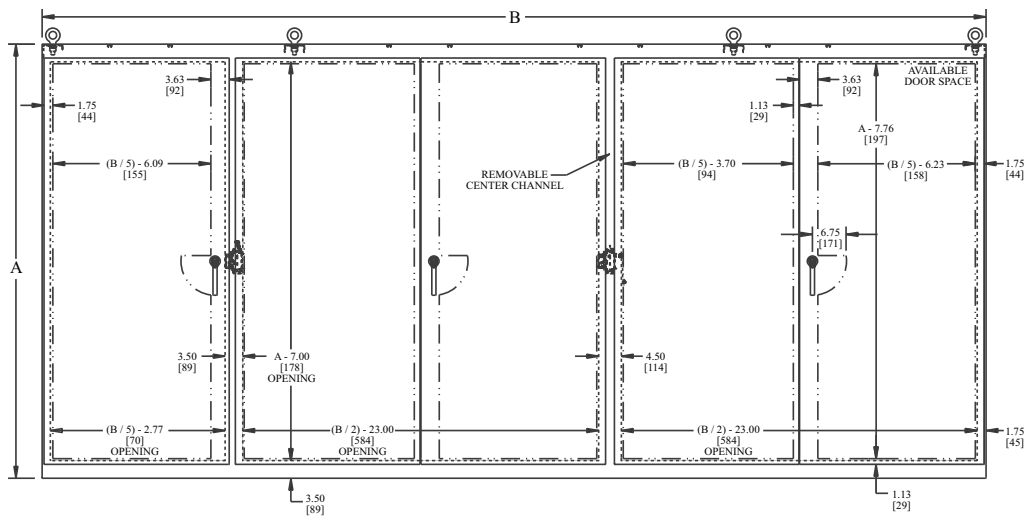

Phone (989) 799-6871  
Fax (989) 799-4524

## Multi-Door Free-Standing / Wall- Mount Enclosures For Flange-Mounted Disconnects

### Application -

Designed to easily accommodate various types of mounting methods with minimal modifications. Provisions are provided in the back of the enclosure for wall or frame mounting, and in the bottom for wall mount brackets, frame mount, or partial provisions for a floor stand kit. Enclosure is designed to house most standard type disconnects. For installation information, consult our Installation Manual at [www.saginawcontrol.com](http://www.saginawcontrol.com).

### Construction -

- 0.104" carbon steel.
- Seams continuously welded and ground smooth.
- Flange trough collar around all sides of door opening.
- Body stiffeners in large enclosures for extra rigidity.
- Heavy duty lifting eyes anchor into reinforced top.
- Removable center posts permit easy sub-panel installation.
- Concealed hinges.
- Black zinc die cast coinproof/padlocking handle on main door with black zinc die cast padlocking handle on slave doors.
- 3-point latching mechanism.
- Ends of latch rods have ramp shoes for easier door closing.
- Panel supports.
- Large removable print pockets.
- Oil-resistant gasket.
- Defeater on master door requires a screwdriver to open.
- Ground stud on door and body.
- Collar studs for mounting optional sub-panel.
- Provisions for light kit.
- Hole plugs provided to seal holes in bottom of enclosure.

**Disconnect switch (or circuit breaker) and operating mechanism are not furnished with enclosure.**

### Finish -

ANSI-61 gray powder coated inside and out. Optional sub-panels powder coated white.

### IS3 - Industry Standards -

NEMA Type 3R, 12 & Type 13  
 UL Listed Type 3R & 12  
 CSA Type 3R & 12  
 IEC 60529 IP55

### IS4 - Industry Standards -

NEMA Type 3R, 4, 12 & Type 13  
 UL Listed Type 3R, 4 & 12  
 CSA Type 3R, 4 & 12  
 IEC 60529 IP66

\*\*\*Special Instructions apply for IS3, IS4 and IS6 to maintain the environmental rating of Type 3R for these parts. See the Special Instructions on the Industry Standards page in the Technical Information Section.

## TWO-DOOR FREE-STANDING / WALL-MOUNT ENCLOSURES FOR FLANGE-MOUNTED DISCONNECTS

ENCLOSURE PRODUCT CODE A2						SUB-PANEL (P3)			
Catalog No.	Height (A)	Width (B)	Depth (C)	Industry Standard	List Price	Catalog No.	Panel Height (D)	Panel Width (E)	List Price
SCE-36X2D5412	36.00	53.75	12.00	IS4	1,463.80	SCE-36P52	32.00	48.00	161.54
SCE-42X2D5412	42.00	53.75	12.00	IS4	1,530.37	SCE-42P52	38.00	48.00	209.39
SCE-48X2D7812	48.00	77.75	12.00	IS3	1,904.94	SCE-48P76	44.00	72.00	351.48
SCE-48X2D7818	48.00	77.75	18.00	IS3	2,125.52	SCE-48P76	44.00	72.00	351.48
SCE-60X2D7818	60.00	77.75	18.00	IS3	2,899.70	SCE-60P76	56.00	72.00	411.28



Phone (989) 799-6871  
 Fax (989) 799-4524



## THREE-DOOR FREE-STANDING / WALL-MOUNT ENCLOSURES FOR FLANGE-MOUNTED DISCONNECTS

ENCLOSURE PRODUCT CODE A2						SUB-PANEL (P3)			
Catalog No.	Height (A)	Width (B)	Depth (C)	Industry Standard	List Price	Catalog No.	Panel Height (D)	Panel Width (E)	List Price
SCE-48X3D11818	48.00	117.50	18.00	IS3	3,065.56	SCE-48P76	44.00	72.00	351.48
						& SCE-48P37	44.00	34.00	148.54

## FOUR-DOOR FREE-STANDING / WALL-MOUNT ENCLOSURES FOR FLANGE-MOUNTED DISCONNECTS

ENCLOSURE PRODUCT CODE A2						SUB-PANEL (P3)			
Catalog No.	Height (A)	Width (B)	Depth (C)	Industry Standard	List Price	Catalog No.	Panel Height (D)	Panel Width (E)	List Price
SCE-48X4D15818	48.00	157.50	18.00	IS3	4,186.87	SCE-48P76 (2)	44.00	72.00	351.48



Phone (989) 799-6871  
Fax (989) 799-4524

## Multi-Door Free-Standing / Wall-Mount Enclosures For Flange-Mounted Disconnects

### Application -

Designed to easily accommodate various types of mounting methods with minimal modifications. Provisions are provided in the back of the enclosure for wall or frame mounting, and in the bottom for wall mount brackets, frame mount, or partial provisions for a floor stand kit. Enclosure is designed to house most standard type disconnects. For installation information, consult our Installation Manual at [www.saginawcontrol.com](http://www.saginawcontrol.com).

### Construction -

- 0.104" carbon steel.
- Seams continuously welded and ground smooth.
- Flange trough collar around all sides of door opening.
- Body stiffeners in large enclosures for extra rigidity.
- Heavy duty lifting eyes anchor into reinforced top.
- Removable center posts permit easy sub-panel installation.
- Concealed hinges.
- Black zinc die cast coinproof/padlocking handle on main door with black zinc die cast padlocking handle on slave doors.
- 3-point latching mechanism.
- Ends of latch rods have ramp shoes for easier door closing.
- Panel supports.
- Large removable print pockets.
- Oil-resistant gasket.
- Defeater on master door requires a screwdriver to open.
- Ground stud on door and body.
- Collar studs for mounting optional sub-panel.
- Provisions for light kit.
- Hole plugs provided to seal holes in bottom of enclosure.

**Disconnect switch (or circuit breaker) and operating mechanism are not furnished with enclosure.**

### Finish -

ANSI-61 gray powder coated inside and out. Optional sub-panels powder coated white.

### IS3 - Industry Standards -

NEMA Type 3R, 12 & Type 13  
UL Listed Type 3R & 12  
CSA Type 3R & 12  
IEC 60529 IP55

### IS4 - Industry Standards -

NEMA Type 3R, 4, 12 & Type 13  
UL Listed Type 3R, 4 & 12  
CSA Type 3R, 4 & 12  
IEC 60529 IP66

\*\*\*Special Instructions apply for IS3, IS4 and IS6 to maintain the environmental rating of Type 3R for these parts. See the Special Instructions on the Industry Standards page in the Technical Information Section.

# MULTI-DOOR FREE-STANDING / WALL-MOUNT ENCLOSURES FOR FLANGE-MOUNTED DISCONNECTS

## TECHNICAL DATA

### TWO-DOOR ENCLOSURE

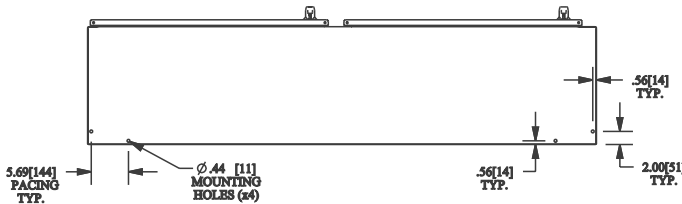
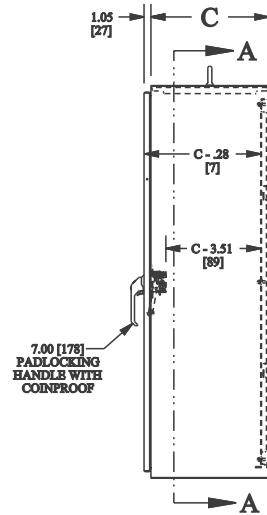
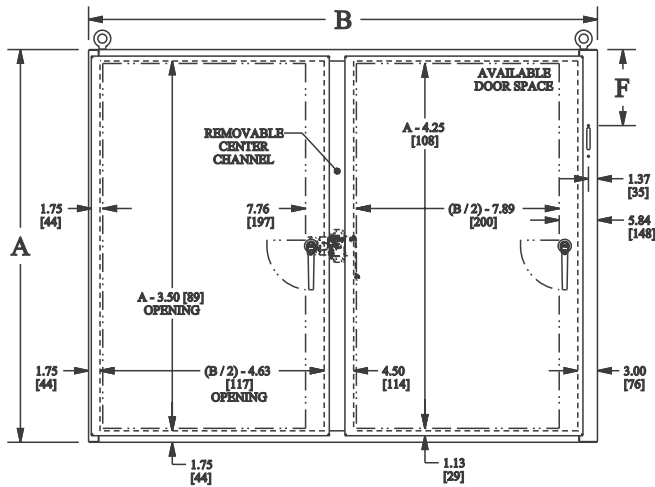
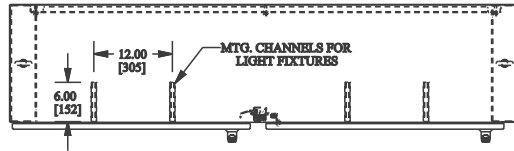

**DISCONNECT NOTES:**  
 F = 4.75 [121] when C = 8.00 [203]  
 F = 7.09 [180] when C = 10.00 [254]  
 F = 11.62 [295] when C = 18.00 [457]

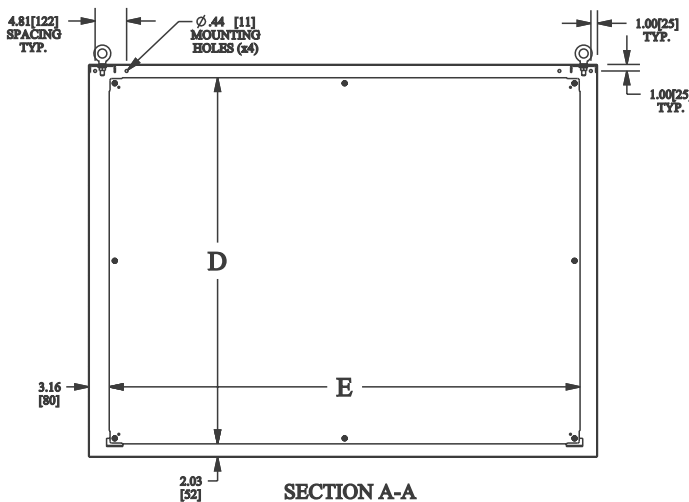



# MULTI-DOOR FREE-STANDING / WALL-MOUNT ENCLOSURES FOR FLANGE-MOUNTED DISCONNECTS

## TECHNICAL DATA

### THREE-DOOR ENCLOSURE

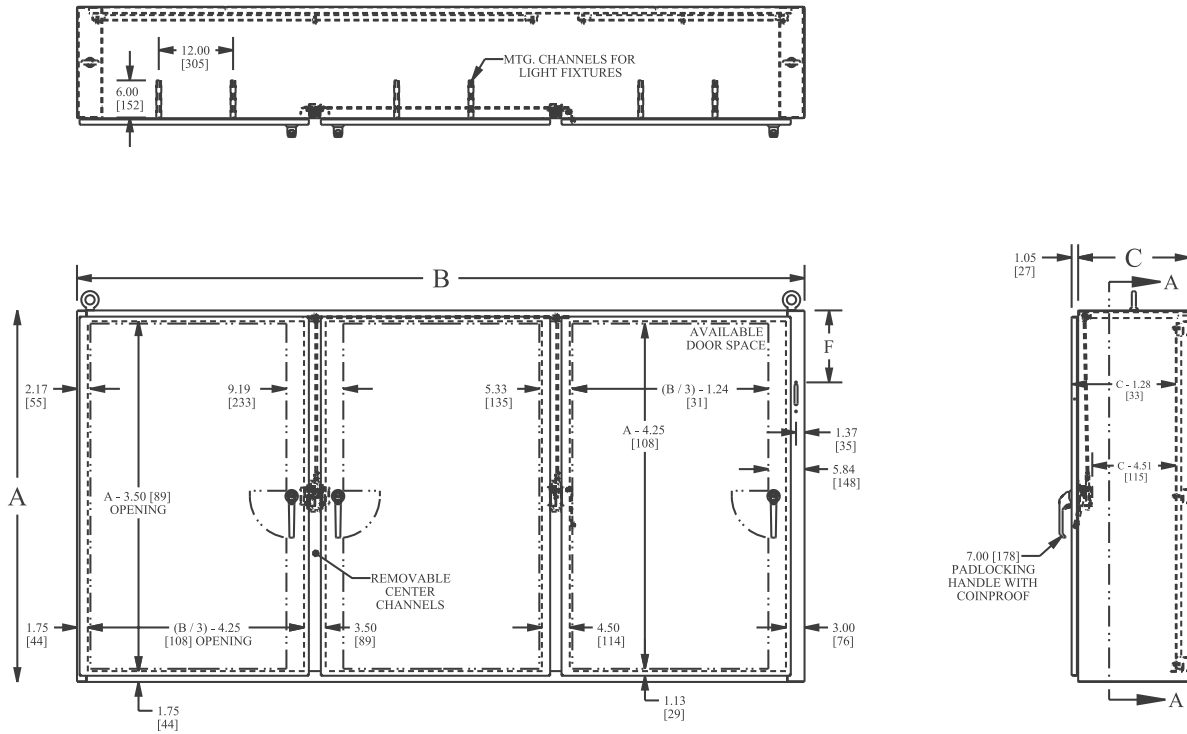

DISCONNECT NOTES:  
 F = 4.75 [121] when C = 8.00 [203]  
 F = 7.09 [180] when C = 10.00 [254]  
 F = 11.62 [295] when C = 18.00 [457]

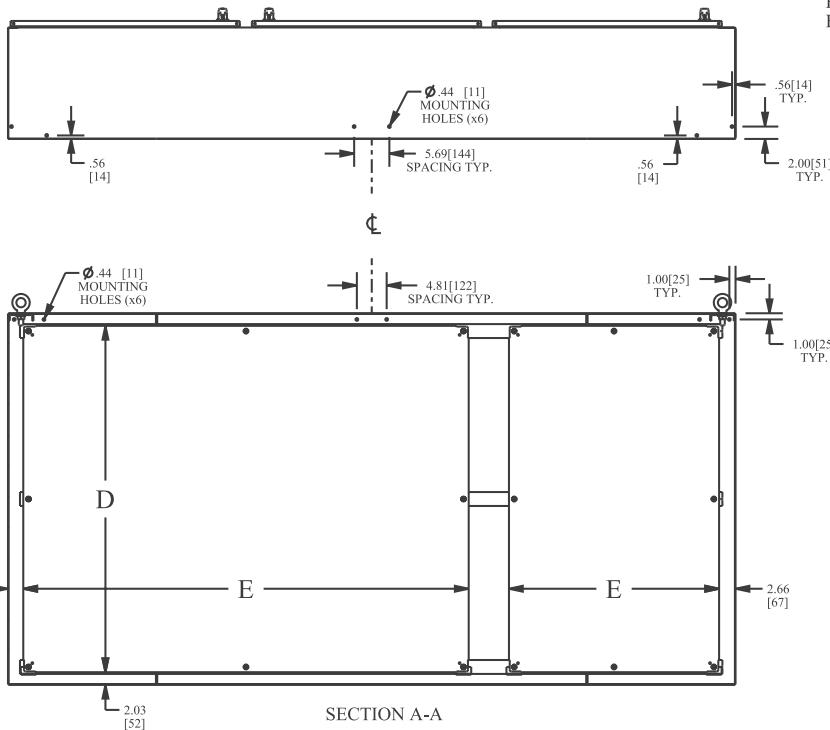

# MULTI-DOOR FREE-STANDING / WALL-MOUNT ENCLOSURES FOR FLANGE-MOUNTED DISCONNECTS

## TECHNICAL DATA

### FOUR-DOOR ENCLOSURE

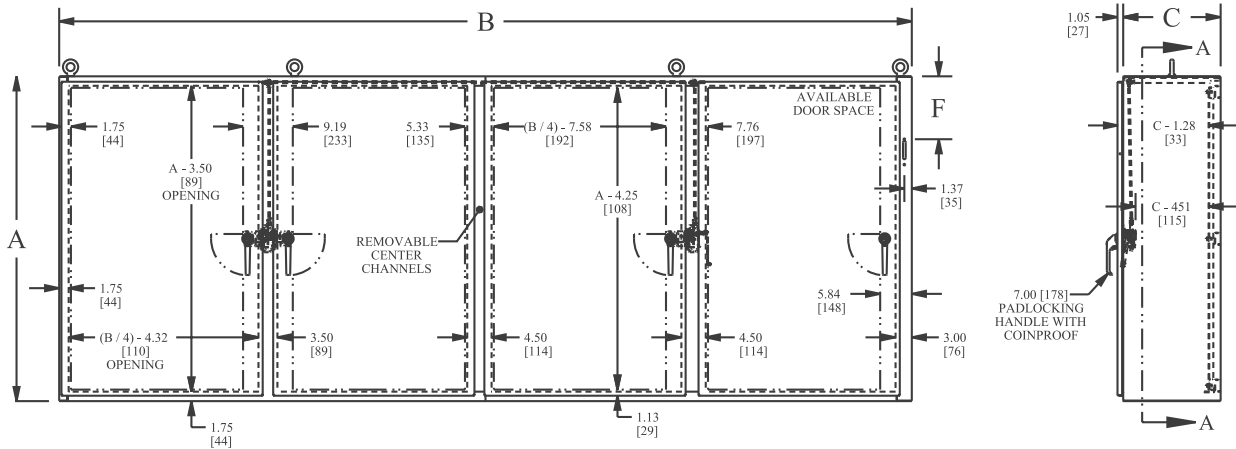
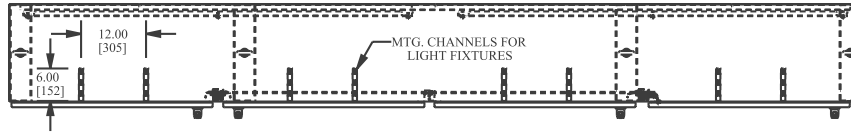

DISCONNECT NOTES:  
 F = 4.75 [121] when C = 8.00 [203]  
 F = 7.09 [180] when C = 10.00 [254]  
 F = 11.62 [295] when C = 18.00 [457]

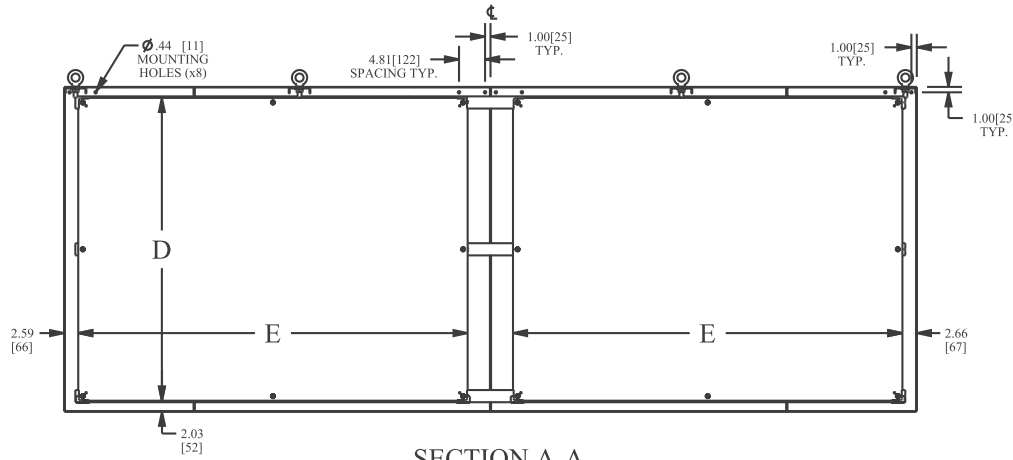
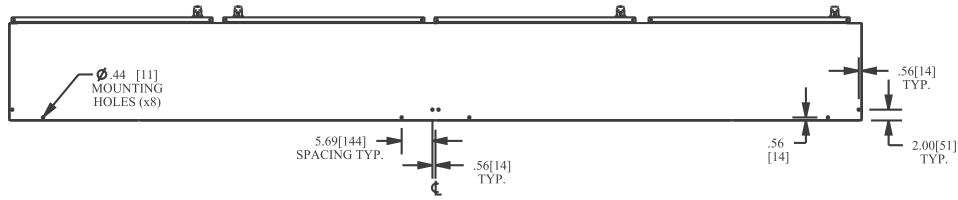

SECTION A-A

# MULTI-DOOR FREE-STANDING / WALL-MOUNT ENCLOSURES FOR FLANGE-MOUNTED DISCONNECTS TECHNICAL DATA

## INSTALLATION OPTIONS

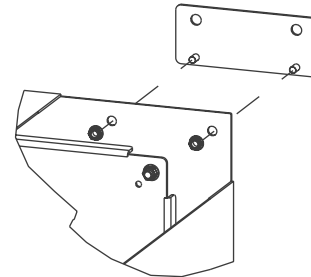
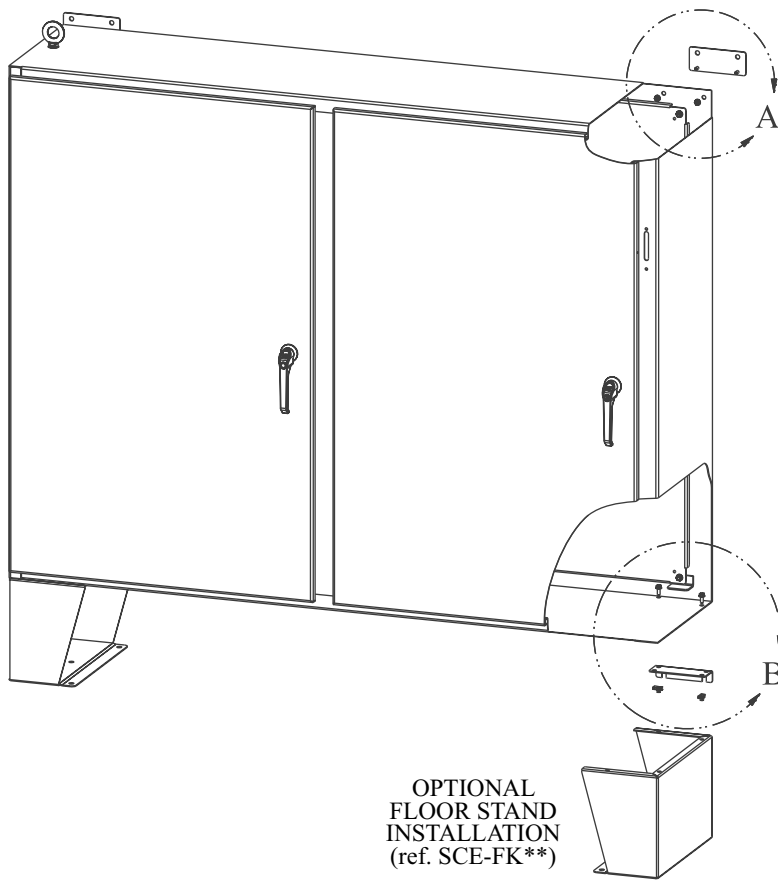

DETAIL A  
OPTIONAL WALL MOUNT INSTALLATION

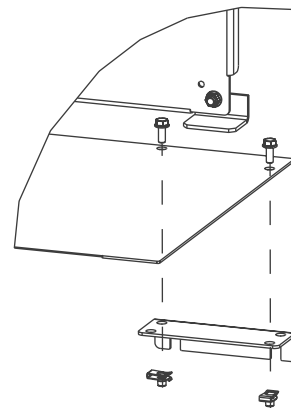

DETAIL B  
OPTIONAL WALL MOUNT INSTALLATION (SCE-HDWMK)

NOTE:  
PREFERRED INSTALLATION IS TO MOUNT ENCLOSURE THROUGH THE BACK AND BOTTOM TO THE MOUNTING SURFACE



Phone (989) 799-6871  
Fax (989) 799-4524

## Two-Door Disconnect Enclosures

### Application -

Designed to house most standard type disconnects. For outdoor applications a drip shield and drain holes are required. For installation information, consult our Installation Manual at www.saginawcontrol.com.

### Construction -

- 0.104" carbon steel.
- Seams continuously welded and ground smooth.
- Flange trough collar around all sides of door opening.
- Oil-resistant gasket.
- Concealed hinges.
- Removable and interchangeable doors.
- 3-point latching mechanism.
- Removable print pocket on main door of disconnect enclosures.
- Lifting eyes for easy handling.
- Ground studs on door and body.
- Collar studs provided for mounting optional sub-panels.
- Black quarter turn latches as required.
- 15" removable floor stands.
- Removable center post.
- Mechanical interlock
- No door stiffeners required.
- Black zinc die cast coinproof/padlocking handle on main door with black zinc die cast padlocking handle on slave door.
- Provisions for light kit.
- Hole plugs provided to seal holes in bottom of enclosure.

**Disconnect switch (or circuit breaker) and operating mechanism are not furnished with this enclosure.**

### Finish -

ANSI-61 gray powder coated inside and out. Optional sub-panels powder coated white.

### IS3 - Industry Standards -

NEMA Type 3R, 12 & Type 13  
 UL Listed Type 3R & 12  
 CSA Type 3R & 12  
 IEC 60529 IP55

### IS4 - Industry Standards -

NEMA Type 3R, 4, 12 & Type 13  
 UL Listed Type 3R, 4, & 12  
 CSA Type 3R, 4 & 12  
 IEC 60529 IP66

\*\*\*Special Instructions apply for IS3, IS4 and IS6 to maintain the environmental rating of Type 3R for these parts. See the Special Instructions on the Industry Standards page in the Technical Information Section.

## TWO-DOOR ENCLOSURES WITH PROVISION FOR DISCONNECT ON RIGHT FLANGE

ENCLOSURE PRODUCT CODE A2						SUB-PANEL (P3)			
Catalog No.	Height (A)	Width (B)	Depth (C)	Industry Standard	List Price	Catalog No.	Panel Height (D)	Panel Width (E)	List Price
SCE-60XEL4912LP	60.00	49.00	12.00	IS4	2,142.65	SCE-60P48	56.00	44.00	268.38
SCE-60XEL4918LP	60.00	49.00	18.00	IS4	2,333.74	SCE-60P48	56.00	44.00	268.38
SCE-60XEL4924LP	60.00	49.00	24.00	IS4	2,524.84	SCE-60P48	56.00	44.00	268.38
SCE-60XEL6112LP	60.00	61.00	12.00	IS4	2,395.85	SCE-60P60	56.00	56.00	331.68
SCE-60XEL6118LP	60.00	61.00	18.00	IS4	2,609.64	SCE-60P60	56.00	56.00	331.68
SCE-60XEL6124LP	60.00	61.00	24.00	IS4	2,823.42	SCE-60P60	56.00	56.00	331.68
SCE-72XEL6112LP	72.00	61.00	12.00	IS4	2,653.84	SCE-72P60	68.00	56.00	394.98
SCE-72XEL6118LP	72.00	61.00	18.00	IS4	2,883.15	SCE-72P60	68.00	56.00	394.98
SCE-72X7312LP	72.00	73.00	12.00	IS3	2,947.64	SCE-72P72	68.00	68.00	470.93
SCE-72XEL7312LP	72.00	73.00	12.00	IS4	3,036.06	SCE-72P72	68.00	68.00	470.93
SCE-72X7318LP	72.00	73.00	18.00	IS3	3,202.04	SCE-72P72	68.00	68.00	470.93
SCE-72XEL7318LP	72.00	73.00	18.00	IS4	3,298.10	SCE-72P72	68.00	68.00	470.93
SCE-72X7324LP	72.00	73.00	24.00	IS3	3,457.63	SCE-72P72	68.00	68.00	470.93
SCE-72XEL7324LP	72.00	73.00	24.00	IS4	3,561.36	SCE-72P72	68.00	68.00	470.93

Part numbers that contain the letter "EL" with doors that are over 30 Inches wide have quarter turn latches on the center of the door top and bottom.



Phone (989) 799-6871  
 Fax (989) 799-4524



# TWO-DOOR DISCONNECT ENCLOSURES

## TECHNICAL DATA

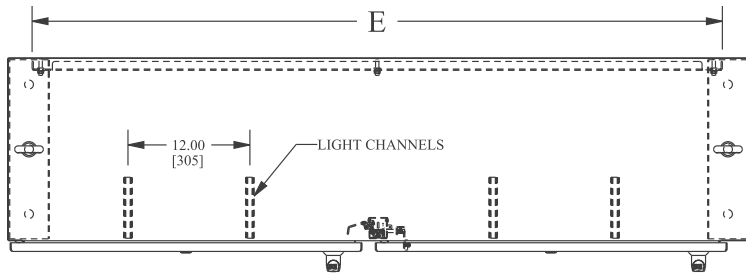

**DISCONNECT NOTES:**

F = 7.88 [200] when A = 60.00 [1524]

F = 13.38 [340] when A = 72.00 [1829]

**LATCH NOTES:**

“EL” part numbers with doors  $\geq 30.00$  [762] in width have additional latch centered top and bottom of door.

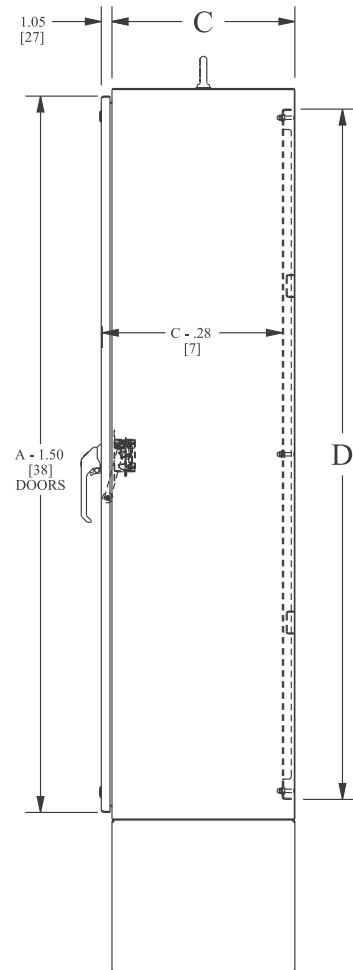
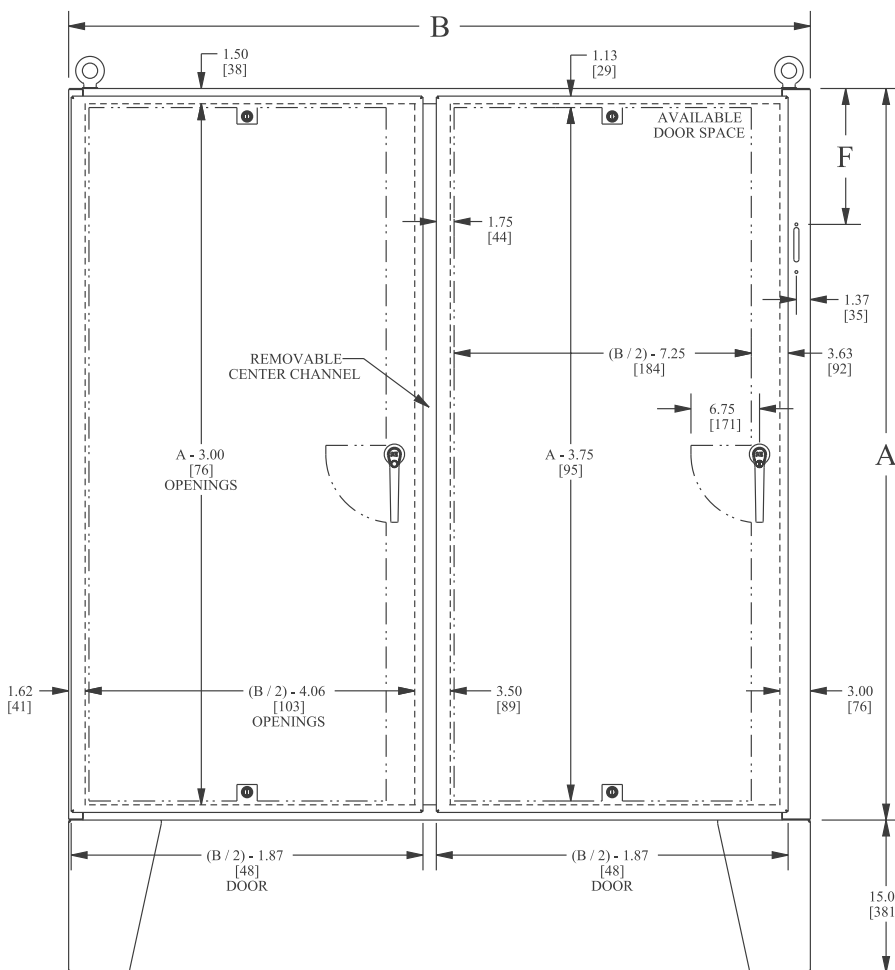

Phone (989) 799-6871  
Fax (989) 799-4524

## Heavy Duty Free-Standing Enclosures For Flange-Mounted Disconnects

### Application -

Designed to house electrical equipment and provide degree of protection from dirt, dust, oil and water and to house most standard type disconnects. For installation information, consult our Installation Manual at www.saginawcontrol.com.

### Construction -

- 0.125" carbon steel.
- Seams continuously welded and ground smooth.
- Flange trough collar around all sides of door opening.
- Body stiffeners in large enclosures for extra rigidity.
- Heavy duty lifting eyes anchor into reinforced top.
- Removable center posts permit easy sub-panel installation.
- Concealed hinges.
- Black zinc die cast coinproof/padlocking handle on main door with black zinc die cast padlocking handle on slave doors.
- 3-point latching mechanism.
- Ends of latch rods have ramp shoes for easier door closing.
- Panel supports.
- Large removable print pockets.
- Oil-resistant gasket.
- Removable sub-panels mount on collar studs.
- Defeater on master door requires a screwdriver to open.
- Hole plugs provided to seal holes in bottom of enclosure.
- Ground stud on door and body.
- Provisions for light kit.

**Disconnect switch (or circuit breaker) and operating mechanism are not furnished with enclosure.**

### Finish -

ANSI-61 gray powder coated inside and out. Sub-panels powder coated white.

#### IS3 - Industry Standards -

NEMA Type 3R, 12 & Type 13  
 UL Listed Type 3R & 12  
 CSA Type 3R & 12  
 IEC 60529 IP55

#### IS4 - Industry Standards -

NEMA Type 3R, 4, 12 & Type 13  
 UL Listed Type 3R, 4 & 12  
 CSA Type 3R, 4 & 12  
 IEC 60529 IP66

\*\*\*Special Instructions apply for IS3, IS4 and IS6 to maintain the environmental rating of Type 3R for these parts. See the Special Instructions on the Industry Standards page in the Technical Information Section.

## HEAVY DUTY FREE-STANDING ENCLOSURES FOR FLANGE-MOUNTED DISCONNECTS SINGLE-DOOR ENCLOSURES

ENCLOSURE PRODUCT CODE A2						SUB-PANEL (P3)			
Catalog No.	Height (A)	Width (B)	Depth (C)	Industry Standard	List Price	Catalog No.	Panel Height (D)	Panel Width (E)	List Price
SCE-72XM2818	72.00	27.50	18.00	IS4	1,565.79	SCE-64P25**	60.00	21.75	1,150.00
SCE-72XM2818G	72.00	27.50	18.00	IS4	1,592.07	SCE-64P25GALV**	60.00	21.75	1,180.00
SCE-72XM3418	72.00	33.50	18.00	IS3	1,735.38	SCE-64P31**	60.00	27.75	1,160.00
SCE-72XM3418G	72.00	33.50	18.00	IS3	1,763.93	SCE-64P31GALV**	60.00	27.75	1,190.00
SCE-72XM4018	72.00	39.50	18.00	IS3	1,904.98	SCE-64P37**	60.00	33.75	1,180.00
SCE-72XM4018G	72.00	39.50	18.00	IS3	1,935.02	SCE-64P37GALV**	60.00	33.75	1,200.00
SCE-84XM4018	84.00	39.50	18.00	IS3	2,117.56	SCE-76P37**	72.00	33.75	1,250.00
SCE-84XM4018G	84.00	39.50	18.00	IS3	2,158.87	SCE-76P37GALV**	72.00	33.75	1,280.00
SCE-84XM4024	84.00	39.50	24.00	IS3	2,177.29	SCE-76P37**	72.00	33.75	1,250.00
SCE-84XM4024G	84.00	39.50	24.00	IS3	2,218.61	SCE-76P37GALV**	72.00	33.75	1,280.00
SCE-90XM4018	90.00	39.50	18.00	IS3	2,268.06	SCE-82P37**	78.00	33.75	1,270.00
SCE-90XM4018G	90.00	39.50	18.00	IS3	2,268.06	SCE-82P37GALV**	78.00	33.75	1,300.00
SCE-90XM4024	90.00	39.50	24.00	IS3	2,428.09	SCE-82P37**	78.00	33.75	1,270.00
SCE-90XM4024G	90.00	39.50	24.00	IS3	2,474.01	SCE-82P37GALV**	78.00	33.75	1,300.00

### XM ENCLOSURES

\* Add the letter U to the end of the part number for enclosures with a universal disconnect cutout.

Standard Disconnect cutout provided

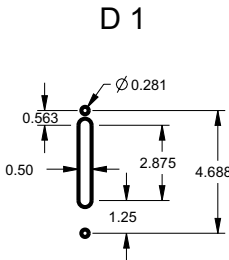

Universal Disconnect cutout

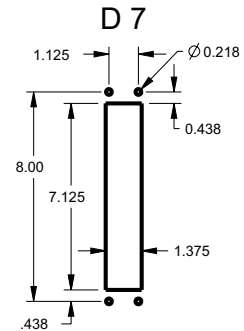

Part numbers ending in "G" have galvanized sub-panels installed.

\*\* Sub-panel included with enclosure. Replacement sub-panels can be ordered. Prices found in the accessory section.

Phone (989) 799-6871  
 Fax (989) 799-4524



# HEAVY DUTY FREE-STANDING ENCLOSURES FOR FLANGE-MOUNTED DISCONNECTS

## TWO-DOOR ENCLOSURES

ENCLOSURE PRODUCT CODE A2						SUB-PANEL (P3)			
Catalog No.	Height (A)	Width (B)	Depth (C)	Industry Standard	List Price	Catalog No.	Panel Height (D)	Panel Width (E)	List Price
SCE-72XM5418	72.00	53.75	18.00	IS4	2,748.19	SCE-64P52**	60.00	48.00	1,334.00
SCE-72XM5418G	72.00	53.75	18.00	IS4	2,792.29	SCE-64P52GALV**	60.00	48.00	1,384.00
SCE-72XM6618	72.00	65.75	18.00	IS3	3,096.93	SCE-64P64**	60.00	60.00	1,602.00
SCE-72XM6618G	72.00	65.75	18.00	IS3	3,220.91	SCE-64P64GALV**	60.00	60.00	1,652.00
SCE-72XM7818	72.00	77.75	18.00	IS3	3,444.49	SCE-64P76**	60.00	72.00	1,825.00
SCE-72XM7818G	72.00	77.75	18.00	IS3	3,561.16	SCE-64P76GALV**	60.00	72.00	1,875.00
SCE-72XM7824	72.00	77.75	24.00	IS3	3,691.72	SCE-64P76**	60.00	72.00	1,825.00
SCE-72XM7824G	72.00	77.75	24.00	IS3	3,808.59	SCE-64P76GALV**	60.00	72.00	1,875.00
SCE-84XM7818	84.00	77.75	18.00	IS3	3,823.10	SCE-76P76**	72.00	72.00	1,900.00
SCE-84XM7818G	84.00	77.75	18.00	IS3	3,934.93	SCE-76P76GALV**	72.00	72.00	1,920.00
SCE-84XM7824	84.00	77.75	24.00	IS3	3,870.87	SCE-76P76**	72.00	72.00	1,900.00
SCE-84XM7824G	84.00	77.75	24.00	IS3	4,007.90	SCE-76P76GALV**	72.00	72.00	1,920.00
SCE-90XM7818	90.00	77.75	18.00	IS3	4,082.27	SCE-82P76**	78.00	72.00	1,900.00
SCE-90XM7818G	90.00	77.75	18.00	IS3	4,220.65	SCE-82P76GALV**	78.00	72.00	1,920.00
SCE-90XM7824	90.00	77.75	24.00	IS3	4,284.12	SCE-82P76**	78.00	72.00	1,900.00
SCE-90XM7824G	90.00	77.75	24.00	IS3	4,421.86	SCE-82P76GALV**	78.00	72.00	1,920.00

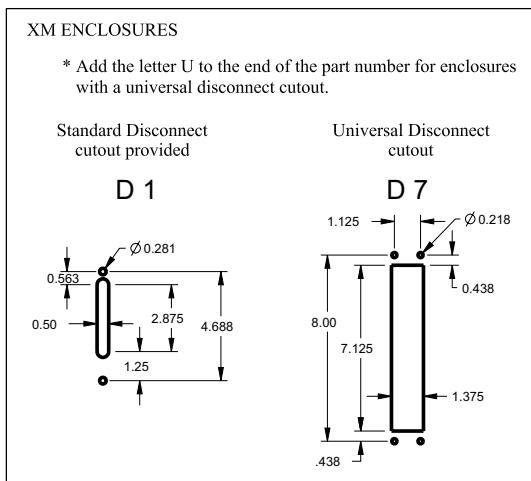

Part numbers ending in "G" have galvanized sub-panels installed.

\*\* Sub-panel included with enclosure. Replacement sub-panels can be ordered. Prices found in the accessory section.



Phone (989) 799-6871  
Fax (989) 799-4524

## Heavy Duty Free-Standing Enclosures For Flange-Mounted Disconnects

### Application -

Designed to house electrical equipment and provide degree of protection from dirt, dust, oil and water and to house most standard type disconnects. For installation information, consult our Installation Manual at www.saginawcontrol.com.

### Construction -

- 0.125" carbon steel.
- Seams continuously welded and ground smooth.
- Flange trough collar around all sides of door opening.
- Body stiffeners in large enclosures for extra rigidity.
- Heavy duty lifting eyes anchor into reinforced top.
- Removable center posts permit easy sub-panel installation.
- Concealed hinges.
- Black zinc die cast coinproof/padlocking handle on main door with black zinc die cast padlocking handle on slave doors.
- 3-point latching mechanism.
- Ends of latch rods have ramp shoes for easier door closing.
- Panel supports.
- Large removable print pockets.
- Oil-resistant gasket.
- Removable sub-panels mount on collar studs.
- Master door is far right-hand door on all enclosures.
- Defeater on master door requires a screwdriver to open.
- Mechanical interlock activated by master door prevents slave doors from being opened first. Doors can be closed in any order.
- Hole plugs provided to seal holes in bottom of enclosure.
- Ground stud on door and body.
- Provisions for light kit.

**Disconnect switch (or circuit breaker) and operating mechanism are not furnished with enclosure.**

### Finish -

ANSI-61 gray powder coated inside and out. Sub-panels powder coated white.

### IS3 - Industry Standards -

NEMA Type 3R, 12 & Type 13  
UL Listed Type 3R & 12  
CSA Type 3R & 12  
IEC 60529 IP55

### IS4 - Industry Standards -

NEMA Type 3R, 4, 12 & Type 13  
UL Listed Type 3R, 4 & 12  
CSA Type 3R, 4 & 12  
IEC 60529 IP66

\*\*\*Special Instructions apply for IS3, IS4 and IS6 to maintain environmental rating of Type 3R for these parts. See the Special Instructions on the Industry Standards page in the Technical Information Section.

## Heavy Duty Free-Standing Enclosures For Flange-Mounted Disconnects

### Application -

Designed to house electrical equipment and provide degree of protection from dirt, dust, oil and water and to house most standard type disconnects. For installation information, consult our Installation Manual at [www.saginawcontrol.com](http://www.saginawcontrol.com).

### Construction -

- 0.125" carbon steel.
- Seams continuously welded and ground smooth.
- Flange trough collar around all sides of door opening.
- Body stiffeners in large enclosures for extra rigidity.
- Heavy duty lifting eyes anchor into reinforced top.
- Removable center posts permit easy sub-panel installation.
- Concealed hinges.
- Black zinc die cast coinproof/padlocking handle on main door with black zinc die cast padlocking handle on slave doors.
- 3-point latching mechanism.
- Ends of latch rods have ramp shoes for easier door closing.
- Panel supports.
- Large removable print pockets.
- Oil-resistant gasket.
- Removable panels mount on collar studs.
- Master door is far right-hand door on all enclosures.
- Defeater on master door requires a screwdriver to open.
- Mechanical interlock activated by master door prevents slave doors from being opened first. Doors can be closed in any order.
- Hole plugs provided to seal holes in bottom of enclosure.
- Ground stud on door and body.
- Provisions for light kit.

**Disconnect switch (or circuit breaker) and operating mechanism are not furnished with enclosure.**

### Finish -

ANSI-61 gray powder coated inside and out. Sub-panels powder coated white.

### IS3 - Industry Standards -

- NEMA Type 3R, 12 & Type 13
- UL Listed Type 3R & 12
- CSA Type 3R & 12
- IEC 60529 IP55

\*\*\*Special Instructions apply for IS3, IS4 and IS6 to maintain the environmental rating of Type 3R for these parts. See Special Instructions on the Industry Standards page in the Technical Information Section.

## HEAVY DUTY FREE-STANDING ENCLOSURES FOR FLANGE-MOUNTED DISCONNECTS THREE-DOOR ENCLOSURES

ENCLOSURE PRODUCT CODE A2						SUB-PANEL (P3)			
Catalog No.	Height (A)	Width (B)	Depth (C)	Industry Standard	List Price	Catalog No.	Panel Height (D)	Panel Width (E)	List Price
SCE-72XM3EQ18	72.00	99.50	18.00	IS3	4,363.92	SCE-64P31** & SCE-64P64**	60.00	27.75	1167.00
SCE-72XM3EQ18G	72.00	99.50	18.00	IS3	4,498.58	SCE-64P31GALV** & SCE-64P64GALV**	60.00	27.75	1180.00
SCE-72XM3EW18	72.00	117.50	18.00	IS3	4,912.10	SCE-64P37** & SCE-64P76**	60.00	33.75	1180.00
SCE-72XM3EW18G	72.00	117.50	18.00	IS3	5,067.85	SCE-64P37GALV** & SCE-64P76GALV**	60.00	33.75	1200.00
SCE-84XM3EW18	84.00	117.50	18.00	IS3	5,476.74	SCE-76P37** & SCE-76P76**	72.00	33.75	1250.00
SCE-84XM3EW18G	84.00	117.50	18.00	IS3	5,665.82	SCE-76P37GALV** & SCE-76P76GALV**	72.00	33.75	1280.00
SCE-84XM3EW24	84.00	117.50	24.00	IS3	5,541.31	SCE-76P37** & SCE-76P76**	72.00	33.75	1250.00
SCE-84XM3EW24G	84.00	117.50	24.00	IS3	5,730.36	SCE-76P37GALV** & SCE-76P76GALV**	72.00	33.75	1280.00
SCE-90XM3EW24	90.00	117.50	24.00	IS3	6,111.01	SCE-82P37** & SCE-82P76**	78.00	33.75	1270.00
SCE-90XM3EW24G	90.00	117.50	24.00	IS3	6,305.68	SCE-82P37GALV** & SCE-82P76GALV**	78.00	33.75	1300.00

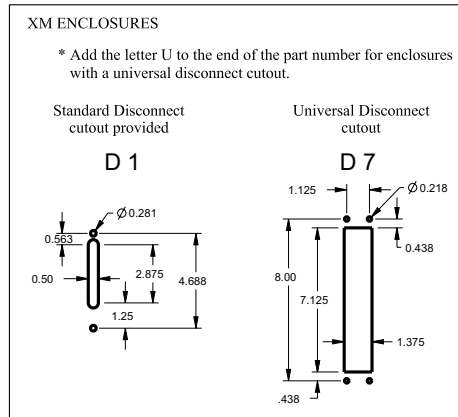

Part numbers ending in "G" have galvanized sub-panels installed.

\*\*Sub-panel included with enclosure. Replacement sub-panels can be ordered. Prices found in the accessory section.



## HEAVY DUTY FREE-STANDING ENCLOSURES FOR FLANGE-MOUNTED DISCONNECTS FOUR-DOOR ENCLOSURES



ENCLOSURE PRODUCT CODE A2						SUB-PANEL (P3)			
Catalog No.	Height (A)	Width (B)	Depth (C)	Industry Standard	List Price	Catalog No.	Panel Height (D)	Panel Width (E)	List Price
SCE-84XM4EW18	84.00	157.50	18.00	IS3	7,541.85	SCE-76P76**(2)	72.00	72.00	1,600.00
SCE-84XM4EW18G	84.00	157.50	18.00	IS3	7,837.86	SCE-76P76GALV**(2)	72.00	72.00	1,620.00
SCE-84XM4EW24	84.00	157.50	24.00	IS3	7,622.34	SCE-76P76**(2)	72.00	72.00	1,600.00
SCE-84XM4EW24G	84.00	157.50	24.00	IS3	7,918.37	SCE-76P76GALV**(2)	72.00	72.00	1,620.00
SCE-90XM4EW18	90.00	157.50	18.00	IS3	7,834.29	SCE-82P76**(2)	78.00	72.00	1,500.00
SCE-90XM4EW18G	90.00	157.50	18.00	IS3	8,131.80	SCE-82P76GALV**(2)	78.00	72.00	1,620.00
SCE-90XM4EW24	90.00	157.50	24.00	IS3	8,022.10	SCE-82P76**(2)	78.00	72.00	1,500.00
SCE-90XM4EW24G	90.00	157.50	24.00	IS3	8,319.62	SCE-82P76GALV**(2)	78.00	72.00	1,620.00

## FIVE-DOOR ENCLOSURES

ENCLOSURE PRODUCT CODE A2						SUB-PANEL (P3)			
Catalog No.	Height (A)	Width (B)	Depth (C)	Industry Standard	List Price	Catalog No.	Panel Height (D)	Panel Width (E)	List Price
SCE-84XM5EW18	84.00	196.75	18.00	IS3	9,174.91	SCE-76P76**(2)	72.00	72.00	1,600.00
SCE-84XM5EW18G	84.00	196.75	18.00	IS3	9,521.77	SCE-76P76GALV**(2)	72.00	72.00	1,620.00
SCE-84XM5EW24	84.00	196.75	24.00	IS3	9,455.00	SCE-76P76**(2)	72.00	72.00	1,600.00
SCE-84XM5EW24G	84.00	196.75	24.00	IS3	9,801.96	SCE-76P76GALV**(2)	72.00	72.00	1,620.00
SCE-90XM5EW18	90.00	196.75	18.00	IS3	9,584.80	SCE-82P76**(2)	78.00	72.00	1,500.00
SCE-90XM5EW18G	90.00	196.75	18.00	IS3	9,983.32	SCE-82P76GALV**(2)	78.00	72.00	1,620.00
SCE-90XM5EW24	90.00	196.75	24.00	IS3	9,905.90	SCE-82P76**(2)	78.00	72.00	1,500.00
SCE-90XM5EW24G	90.00	196.75	24.00	IS3	10,259.43	SCE-82P76GALV**(2)	78.00	72.00	1,620.00

## SIX-DOOR ENCLOSURES

ENCLOSURE PRODUCT CODE A2						SUB-PANEL (P3)			
Catalog No.	Height (A)	Width (B)	Depth (C)	Industry Standard	List Price	Catalog No.	Panel Height (D)	Panel Width (E)	List Price
SCE-84XM6EW24	84.00	235.00	24.00	IS3	11,522.27	SCE-76P76**(2)	72.00	72.00	1,600.00
SCE-84XM6EW24G	84.00	235.00	24.00	IS3	11,974.53	SCE-76P76GALV**(2)	72.00	72.00	1,620.00
SCE-90XM6EW24	90.00	235.00	24.00	IS3	11,945.82	SCE-82P76**(2)	78.00	72.00	1,500.00
SCE-90XM6EW24G	90.00	235.00	24.00	IS3	12,400.37	SCE-82P76GALV**(2)	78.00	72.00	1,620.00

Part numbers ending in "G" have galvanized sub-panels installed.

\*\*Sub-panel included with enclosure. Replacement sub-panels can be ordered.  
Prices found in the accessory section.

## Heavy Duty Free-Standing Enclosures For Flange-Mounted Disconnects

### Application -

Designed to house electrical equipment and provide degree of protection from dirt, dust, oil and water and to house most standard type disconnects. For installation information, consult our Installation Manual at [www.saginawcontrol.com](http://www.saginawcontrol.com).

### Construction -

- 0.125" carbon steel.
- Seams continuously welded and ground smooth.
- Flange trough collar around all sides of door opening.
- Body stiffeners in large enclosures for extra rigidity.
- Heavy duty lifting eyes anchor into reinforced top.
- Removable center posts permit easy sub-panel installation.
- Concealed hinges.
- Black zinc die cast coinproof/padlocking handle on main door with black zinc die cast padlocking handle on slave doors.
- 3-point latching mechanism.
- Ends of latch rods have ramp shoes for easier door closing.
- Panel supports.
- Large removable print pockets.
- Oil-resistant gasket.
- Removable panels mount on collar studs.
- Master door is far right-hand door on all enclosures.
- Defeater on master door requires a screwdriver to open.
- Mechanical interlock activated by master door prevents slave doors from being opened first. Doors can be closed in any order.
- Hole plugs provided to seal holes in bottom of enclosure.
- Ground stud on door and body.
- Provisions for light kit.

**Disconnect switch (or circuit breaker) and operating mechanism are not furnished with enclosure.**

### Finish -

ANSI-61 gray powder coated inside and out. Sub-panels powder coated white.

### IS3 - Industry Standards -

NEMA Type 3R, 12 & Type 13  
UL Listed Type 3R & 12  
CSA Type 3R & 12  
IEC 60529 IP55

\*\*\*Special Instructions apply for IS3, IS4 and IS6 to maintain the environmental rating of Type 3R for these parts. See Special Instructions on the Industry Standards page in the Technical Information Section.

1 Operator System Enclosures  
 2 Wall-Mount Enclosures  
 3 Free-Standing & Floor-Mounted Enclosures  
 4 Modular Enclosures  
 5 Operator System Enclosures (Stainless Steel)  
 6 Wall-Mount Enclosures (Stainless Steel)  
 7 Free-Standing & Floor-Mounted Enclosures (Stainless Steel)  
 8 Non-Metallic Enclosures  
 9 Accessories  
 10 Technical Information  
 11 Index

# HEAVY DUTY FREE-STANDING ENCLOSURES FOR FLANGE-MOUNTED DISCONNECTS

## TECHNICAL DATA

### SINGLE-DOOR ENCLOSURE

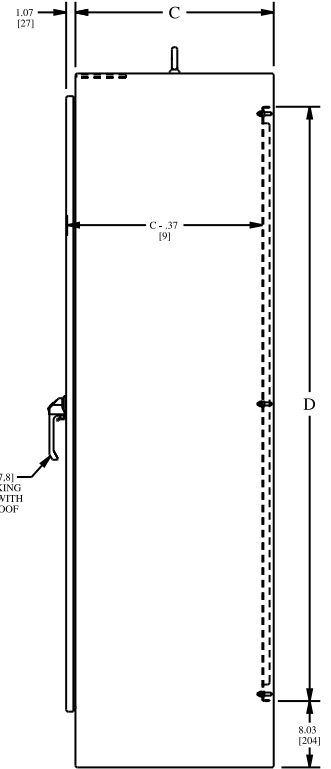
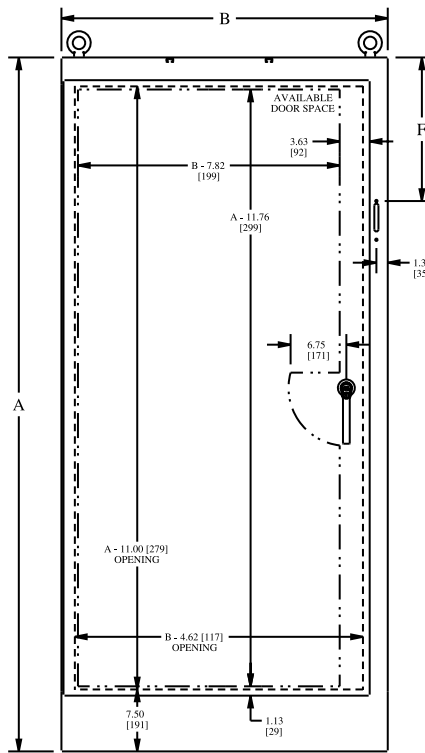
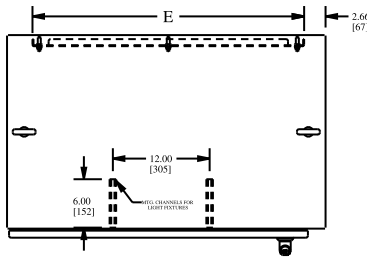

STANDARD DISCONNECTS:  
 F = 11.88 [301,7] when A = 72.00 [1828,8]  
 F = 17.38 [441,4] when A = 84.00 [2133,6]  
 F = 20.38 [517,6] when A = 90.00 [228,6]

U TYPE (Universal) DISCONNECTS:  
 F = 11.88 [301,8] when A = 72  
 F = 17.63 [447,8] when A = 84 & 90

### TWO-DOOR ENCLOSURE

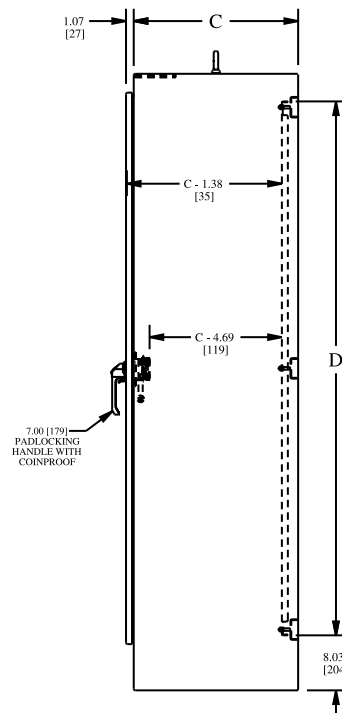
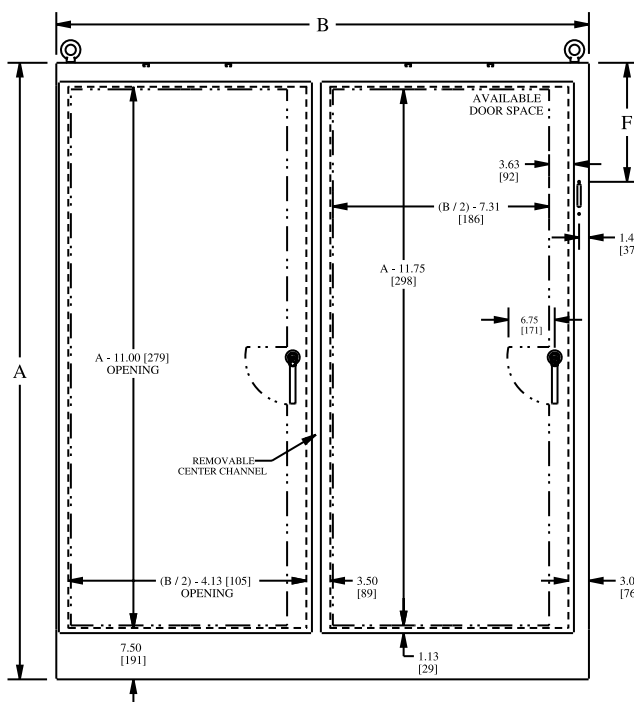

STANDARD DISCONNECTS:  
 F = 11.88 [301,7] when A = 72.00 [1828,8]  
 F = 17.38 [441,4] when A = 84.00 [2133,6]  
 F = 20.38 [517,6] when A = 90.00 [228,6]

U TYPE (Universal) DISCONNECTS:  
 F = 11.88 [301,8] when A = 72  
 F = 17.63 [447,8] when A = 84 & 90

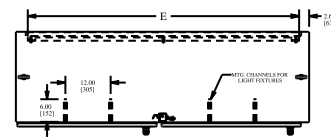

# HEAVY DUTY FREE-STANDING ENCLOSURES FOR FLANGE-MOUNTED DISCONNECTS

## TECHNICAL DATA

### THREE-DOOR ENCLOSURE

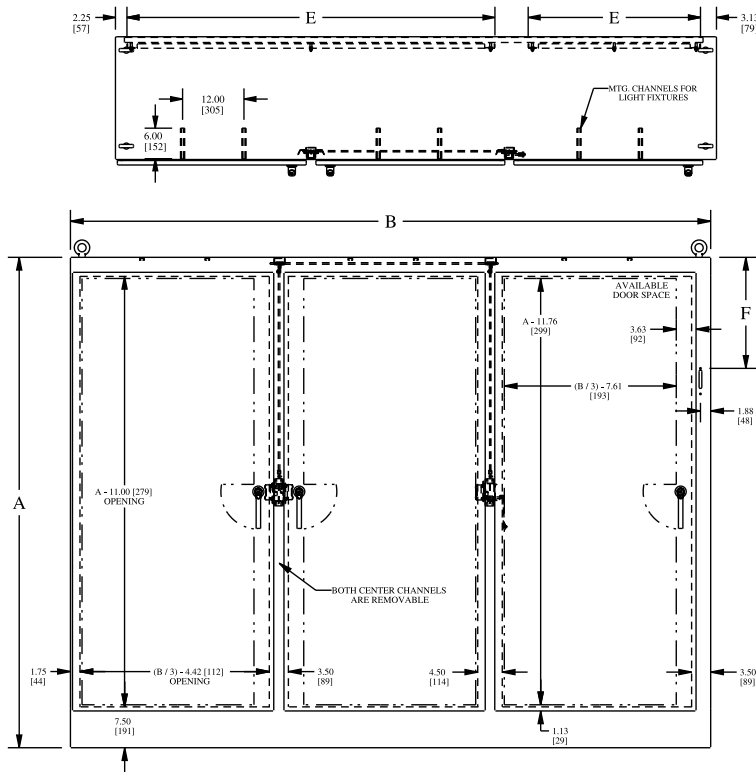

STANDARD DISCONNECTS:  
 F = 11.88 [301,7] when A = 72.00 [1828,8]  
 F = 17.38 [441,4] when A = 84.00 [2133,6]  
 F = 20.38 [517,6] when A = 90.00 [228,6]

U TYPE (Universal) DISCONNECTS:  
 F = 11.88 [301,8] when A = 72  
 F = 17.63 [447,8] when A = 84 & 90

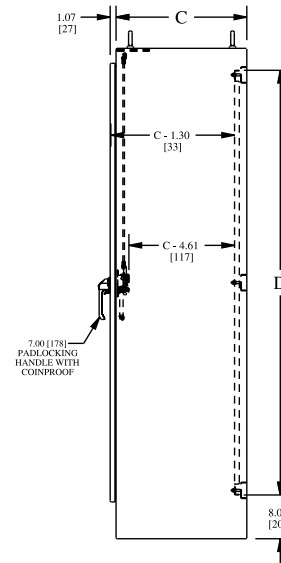

### FOUR-DOOR ENCLOSURE

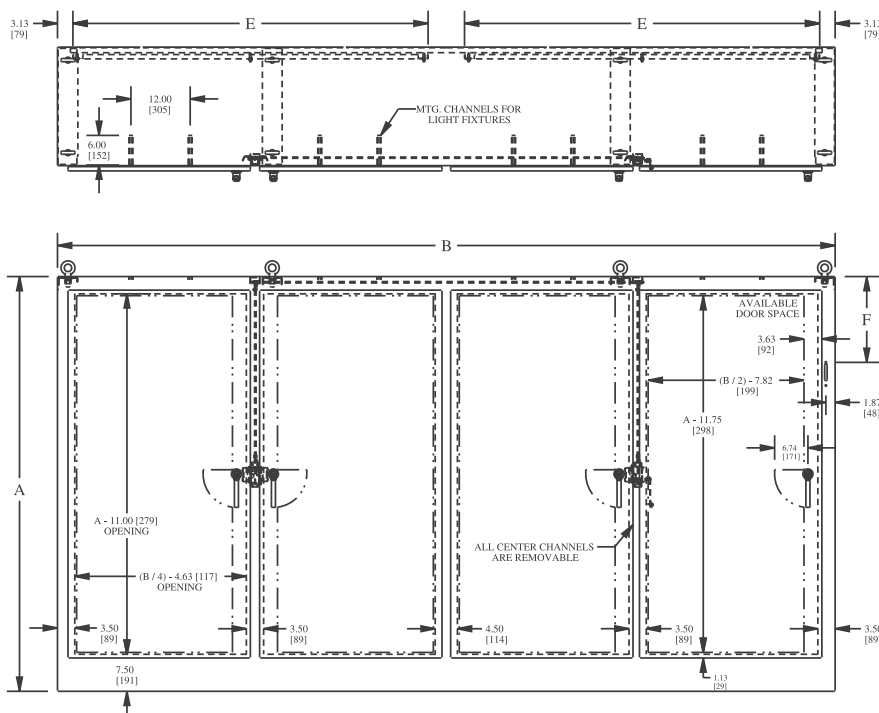

STANDARD DISCONNECTS:  
 F = 11.88 [301,7] when A = 72.00 [1828,8]  
 F = 17.38 [441,4] when A = 84.00 [2133,6]  
 F = 20.38 [517,6] when A = 90.00 [228,6]

U TYPE (Universal) DISCONNECTS:  
 F = 17.63 [447,8]

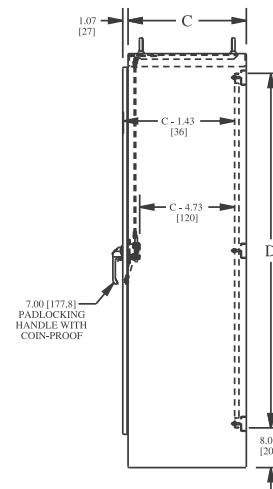

# HEAVY DUTY FREE-STANDING ENCLOSURES FOR FLANGE-MOUNTED DISCONNECTS

## TECHNICAL DATA

### FIVE-DOOR ENCLOSURE

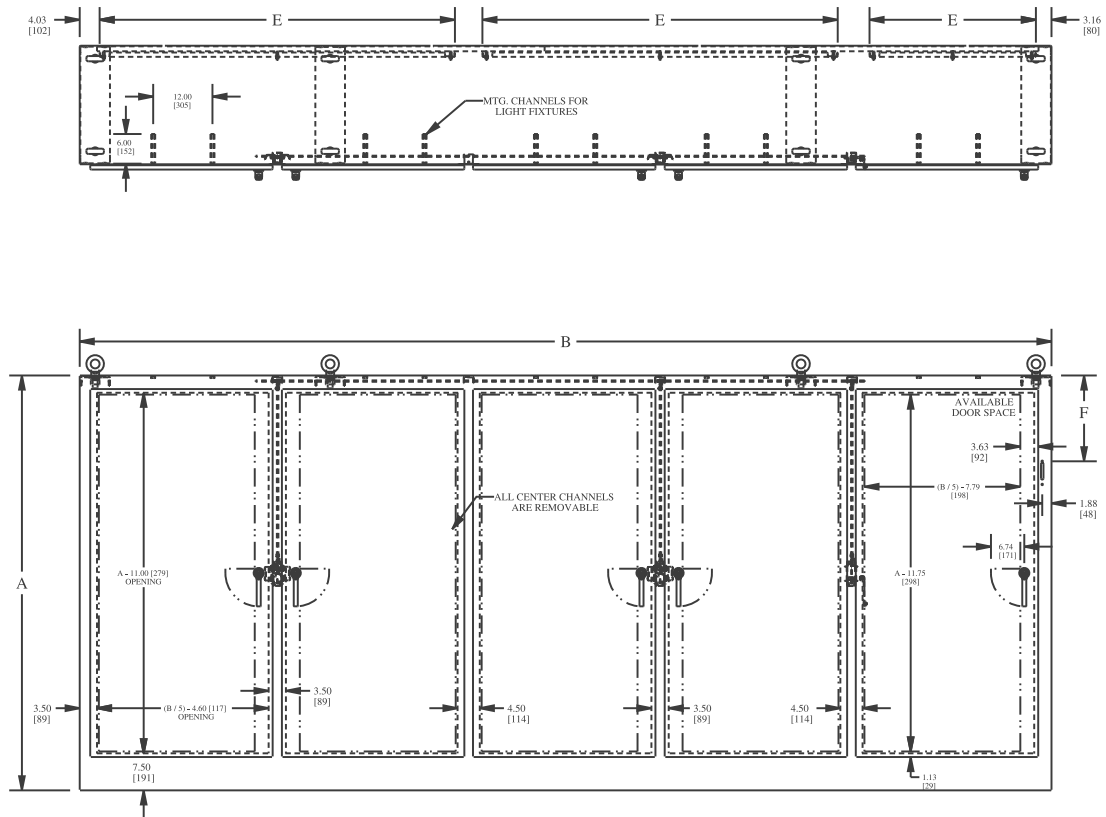

STANDARD DISCONNECTS:  
 F = 11.88 [301,7] when A = 72.00 [1828,8]  
 F = 17.38 [441,4] when A = 84.00 [2133,6]  
 F = 20.38 [517,6] when A = 90.00 [228,6]

U TYPE (Universal) DISCONNECTS:  
 F = 17.63 [447,8]

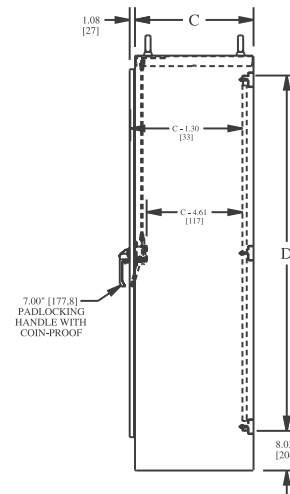

Phone (989) 799-6871  
 Fax (989) 799-4524



# HEAVY DUTY FREE-STANDING ENCLOSURES FOR FLANGE-MOUNTED DISCONNECTS

## TECHNICAL DATA

### SIX-DOOR ENCLOSURE

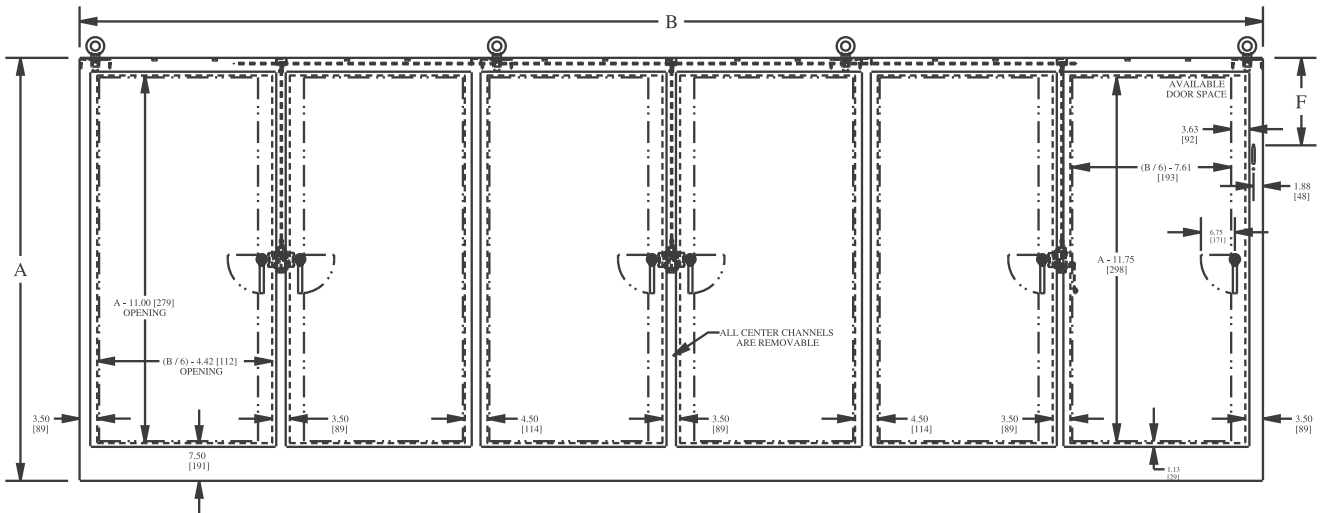
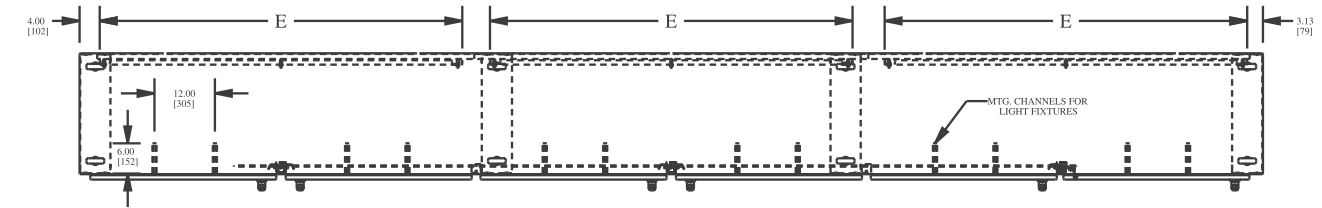

**STANDARD DISCONNECTS:**

F = 11.88 [301,7] when A = 72.00 [1828,8]

F = 17.38 [441,4] when A = 84.00 [2133,6]

F = 20.38 [517,6] when A = 90.00 [228,6]

**U TYPE (Universal) DISCONNECTS:**

F = 17.63 [447,8]

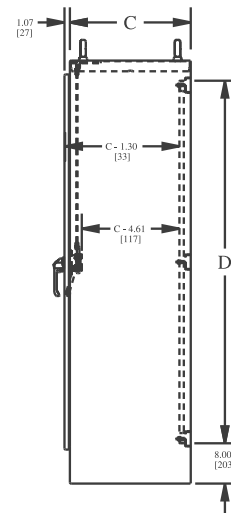

Phone (989) 799-6871

Fax (989) 799-4524

## XD Heavy Duty Free-Standing Enclosures with External Disconnect Enclosure Installed

### Application -

Designed to house the main power supply in external enclosure on the right side of main enclosure, keeping the live side of the power supply separate from the primary electrical equipment. Provides protection from dirt, dust, oil and water and can house most standard type disconnects. For Installation information consult our Installation Manual at www.saginawcontrol.com.

### Construction -

- 0.125" carbon steel.
- Seams continuously welded and ground smooth.
- Flange trough collar around all sides of door opening.
- Body stiffeners in large enclosures for extra rigidity.
- Heavy duty lifting eyes anchor into reinforced top.
- Removable center posts permit easy sub-panel installation.
- Concealed hinges.
- Black zinc die cast padlocking handles.
- 3-point latching mechanism.
- Large removable print pockets.
- Oil-resistant gasket.
- Removable panels mount on collar studs.
- Defeater on master door requires a screwdriver to open.
- Mechanical interlock activated by the External Disconnect prevents main door of the enclosure from being closed unless the EXD enclosure is first closed.
- Mechanical interlock activated by master door prevents slave doors from being opened first. Doors can be closed in any order.
- Hole plugs provided to seal holes in bottom of enclosure.
- Ground stud on door and body.
- Provisions for light kit.

**Disconnect switch (or circuit breaker) and operating mechanism are not furnished with enclosure.**

### Finish -

ANSI-61 gray powder coated inside and out. Sub-panels powder coated white.

#### IS3 - Industry Standards -

- NEMA Type 3R, 12 & Type 13
- UL Listed Type 3R & 12
- CSA Type 3R & 12
- IEC 60529 IP55

#### IS4 - Industry Standards -

- NEMA Type 3R, 4, 12 & Type 13
- UL Listed Type 3R, 4 & 12
- CSA Type 3R, 4 & 12
- IEC 60529 IP66

\*\*\*Special Instructions apply for IS3, IS4 and IS6 to maintain the environmental rating of Type 3R for these parts. See the Special Instructions on the Industry Standards page in the Technical Information Section.

## XD HEAVY DUTY FREE-STANDING ENCLOSURES WITH EXTERNAL DISCONNECT ENCLOSURE INSTALLED SINGLE-DOOR ENCLOSURES

ENCLOSURE PRODUCT CODE A2						SUB-PANEL (P3)			
Catalog No.	Height (A)	Width (B)	Depth (C)	Industry Standard	List Price	Catalog No.	Panel Height (D)	Panel Width (E)	List Price
SCE-72XD2818	72.00	27.50	18.00	IS4	2,697.79	SCE-64P25**	60.00	21.75	1,650.00
SCE-72XD2818G	72.00	27.50	18.00	IS4	2,697.79	SCE-64P25GALV**	60.00	21.75	1,650.00
SCE-72XD3418	72.00	33.50	18.00	IS3	2,867.38	SCE-64P31**	60.00	27.75	1,650.00
SCE-72XD3418G	72.00	33.50	18.00	IS3	2,894.92	SCE-64P31GALV**	60.00	27.75	1,650.00
SCE-72XD4018	72.00	39.50	18.00	IS3	3,036.98	SCE-64P37**	60.00	33.75	1,650.00
SCE-72XD4018G	72.00	39.50	18.00	IS3	3,036.98	SCE-64P37GALV**	60.00	33.75	1,650.00
SCE-84XD4018	84.00	39.50	18.00	IS3	3,249.56	SCE-76P37**	72.00	33.75	1,650.00
SCE-84XD4018G	84.00	39.50	18.00	IS3	3,249.56	SCE-76P37GALV**	72.00	33.75	1,650.00
SCE-90XD4018	90.00	39.50	18.00	IS3	3,400.06	SCE-82P37**	78.00	33.75	1,650.00
SCE-90XD4018G	90.00	39.50	18.00	IS3	3,400.06	SCE-82P37GALV**	78.00	33.75	1,650.00

## TWO-DOOR ENCLOSURES

ENCLOSURE PRODUCT CODE A2						SUB-PANEL (P3)			
Catalog No.	Height (A)	Width (B)	Depth (C)	Industry Standard	List Price	Catalog No.	Panel Height (D)	Panel Width (E)	List Price
SCE-72XD5418	72.00	53.75	18.00	IS4	3,880.19	SCE-64P52**	60.00	48.00	664.00
SCE-72XD5418G	72.00	53.75	18.00	IS4	3,880.19	SCE-64P52GALV**	60.00	48.00	664.00
SCE-72XD6618	72.00	65.75	18.00	IS3	4,228.93	SCE-64P64**	60.00	60.00	664.00
SCE-72XD6618G	72.00	65.75	18.00	IS3	4,352.91	SCE-64P64GALV**	60.00	60.00	664.00
SCE-72XD7818	72.00	77.75	18.00	IS3	4,576.49	SCE-64P76**	60.00	72.00	664.00
SCE-72XD7818G	72.00	77.75	18.00	IS3	4,693.16	SCE-64P76GALV**	60.00	72.00	664.00
SCE-84XD7818	84.00	77.75	18.00	IS3	4,955.10	SCE-76P76**	72.00	72.00	664.00
SCE-84XD7818G	84.00	77.75	18.00	IS3	5,066.93	SCE-76P76GALV**	72.00	72.00	664.00
SCE-90XD7818	90.00	77.75	18.00	IS3	5,214.27	SCE-82P76**	78.00	72.00	664.00
SCE-90XD7818G	90.00	77.75	18.00	IS3	5,352.65	SCE-82P76GALV**	78.00	72.00	664.00



*Part numbers ending in "G" have galvanized sub-panels installed.*

*\*\*Sub-panel included with enclosure.  
Replacement sub-panels can be ordered.  
Prices found in the accessory section.*

Phone (989) 799-6871  
Fax (989) 799-4524



### THREE-DOOR ENCLOSURES

ENCLOSURE PRODUCT CODE A2						SUB-PANEL (P3)			
Catalog No.	Height (A)	Width (B)	Depth (C)	Industry Standard	List Price	Catalog No.	Panel Height (D)	Panel Width (E)	List Price
SCE-72XD3EQ18	72.00	99.50	18.00	IS3	5,563.84	SCE-64P31** & SCE-64P64**	60.00	27.75	1,167.00
SCE-72XD3EQ18G	72.00	99.50	18.00	IS3	5,698.50	SCE-64P31GALV** & SCE-64P64GALV**	60.00	27.75	1,192.00
SCE-72XD3EW18	72.00	117.50	18.00	IS3	6,112.02	SCE-76P37** & SCE-64P76**	72.00	33.75	2,500.00
SCE-72XD3EW18G	72.00	117.50	18.00	IS3	6,267.77	SCE-76P37GALV** & SCE-64P76GALV**	72.00	33.75	2,611.00
SCE-84XD3EW18	84.00	117.50	18.00	IS3	6,676.66	SCE-76P37** & SCE-76P76**	72.00	33.75	2,500.00
SCE-84XD3EW18G	84.00	117.50	18.00	IS3	6,865.73	SCE-76P37GALV** & SCE-76P76GALV**	72.00	33.75	2,681.00



### XD Heavy Duty Free-Standing Enclosures with External Disconnect Enclosure Installed

#### Application -

Designed to house the main power supply in external enclosure on the right side of main enclosure, keeping the live side of the power supply separate from the primary electrical equipment. Provides protection from dirt, dust, oil and water and can house most standard type disconnects. For Installation information consult our Installation Manual at www.saginawcontrol.com.

#### Construction -

- 0.125" carbon steel.
- Seams continuously welded and ground smooth.
- Flange trough collar around all sides of door opening.
- Body stiffeners in large enclosures for extra rigidity.
- Heavy duty lifting eyes anchor into reinforced top.
- Removable center posts permit easy sub-panel installation.
- Concealed hinges.
- Black zinc die cast padlocking handles.
- 3-point latching mechanism.
- Large removable print pockets.
- Oil-resistant gasket.
- Removable panels mount on collar studs.
- Defeater on master door requires a screwdriver to open.
- Mechanical interlock activated by the External Disconnect prevents main door of the enclosure from being closed unless the EXD enclosure is first closed.
- Mechanical interlock activated by master door prevents slave doors from being opened first. Doors can be closed in any order.
- Hole plugs provided to seal holes in bottom of enclosure.
- Ground stud on door and body.
- Provisions for light kit.

**Disconnect switch (or circuit breaker) and operating mechanism are not furnished with enclosure.**

#### Finish -

ANSI-61 gray powder coated inside and out. Sub-panels powder coated white.

#### IS3 - Industry Standards -

NEMA Type 3R, 12 & Type 13  
UL Listed Type 3R & 12  
CSA Type 3R & 12  
IEC 60529 IP55

#### IS4 - Industry Standards -

NEMA Type 3R, 4, 12 & Type 13  
UL Listed Type 3R, 4 & 12  
CSA Type 3R, 4 & 12  
IEC 60529 IP66

\*\*\*Special Instructions apply for IS3, IS4 and IS6 to maintain the environmental rating of Type 3R for these parts. See the Special Instructions on the Industry Standards page in the Technical Information Section.



Phone (989) 799-6871  
Fax (989) 799-4524

# XD HEAVY DUTY FREE-STANDING ENCLOSURES WITH EXTERNAL DISCONNECT ENCLOSURE INSTALLED

## TECHNICAL DATA

### SINGLE-DOOR ENCLOSURE

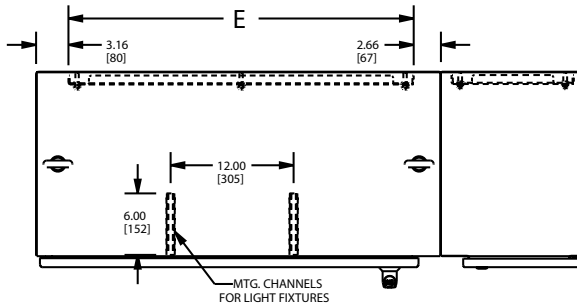

STANDARD DISCONNECTS:  
 F = 0.00 [0] when A = 72.00 [1829]  
 F = 5.50 [138] when A = 84.00 [2134]  
 F = 8.50 [216] when A = 90.00 [2286]

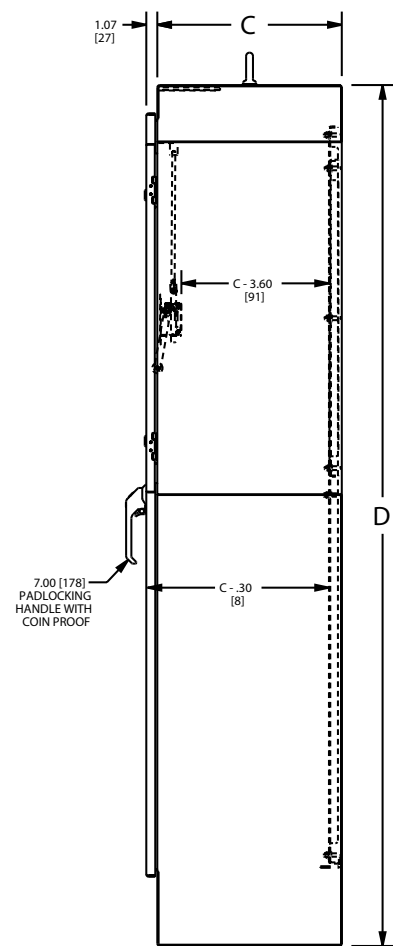
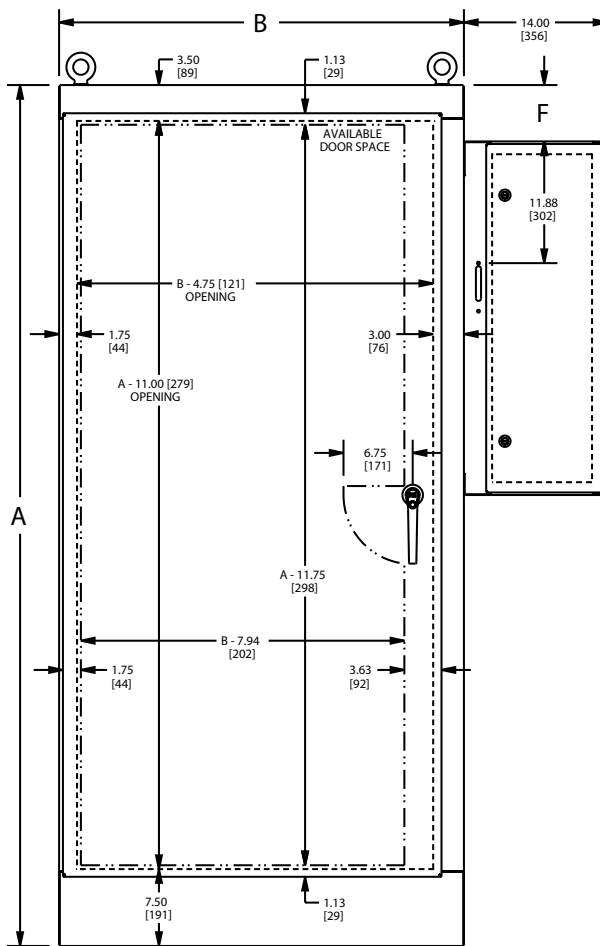

Phone (989) 799-6871  
 Fax (989) 799-4524







# XD HEAVY DUTY FREE-STANDING ENCLOSURES WITH EXTERNAL DISCONNECT ENCLOSURE INSTALLED

## TECHNICAL DATA

### THREE-DOOR ENCLOSURE

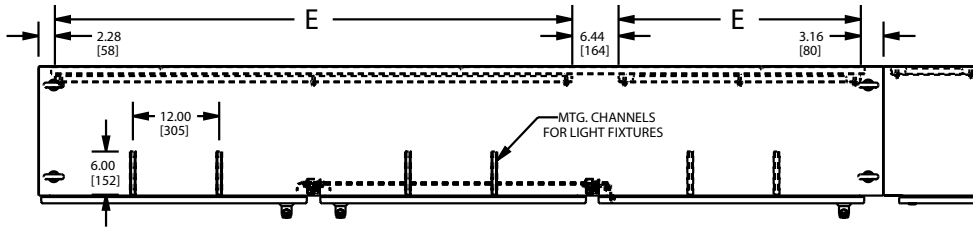

STANDARD DISCONNECTS:  
 F = 0.00 [0] when A = 72.00 [1829]  
 F = 5.50 [138] when A = 84.00 [2134]  
 F = 8.50 [216] when A = 90.00 [2286]

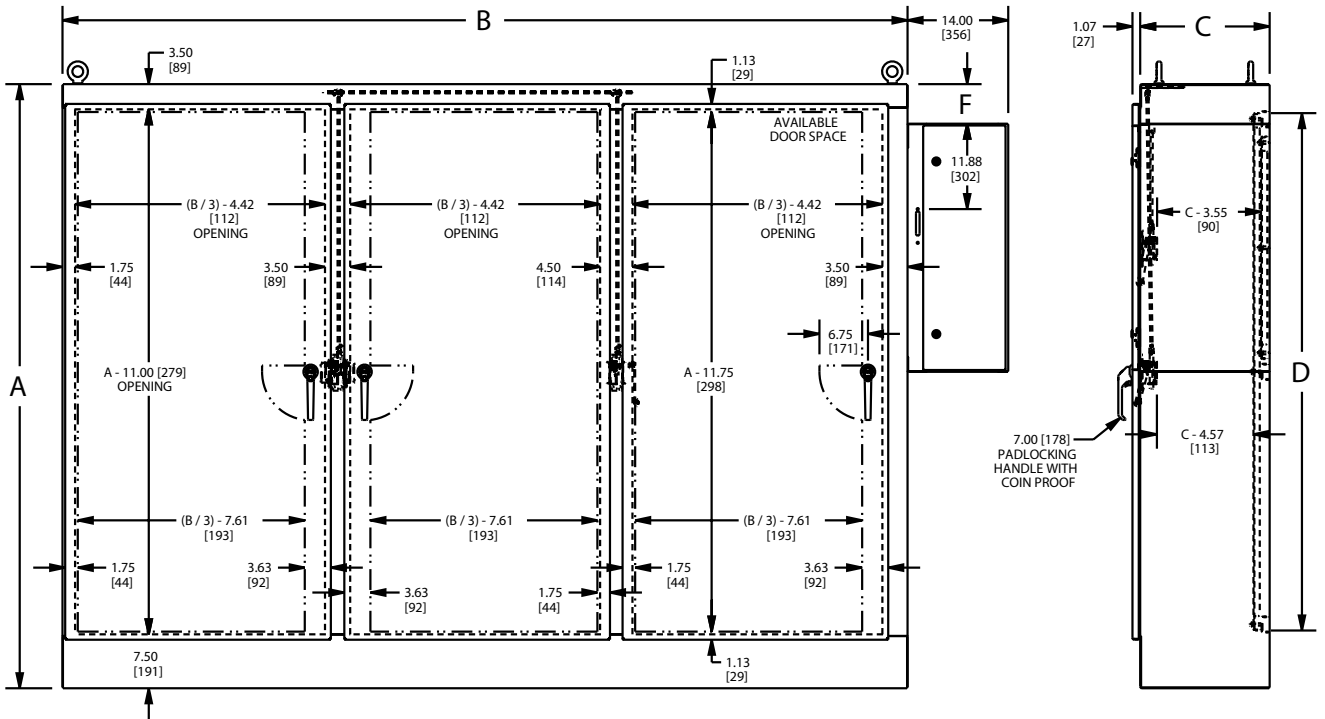

Phone (989) 799-6871  
 Fax (989) 799-4524



# Waste Water Treatment



# Municipality

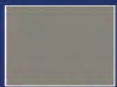

SCE-09 GRAY  
Semi-Gloss



SCE-05 WHITE  
Full Gloss

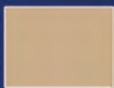

RAL 1015  
Beige  
Full Gloss



RAL 1018  
Yellow  
Full Gloss



RAL 2004  
Orange  
Full Gloss



RAL 3000  
Red  
Full Gloss

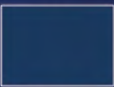

RAL 5010  
Blue  
Full Gloss

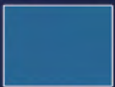

RAL 5015  
Blue  
Full Gloss

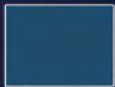

RAL 5019  
Blue  
Full Gloss



RAL 5024  
Blue  
Full Gloss



RAL 8023  
Orange  
Full Gloss

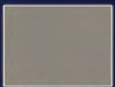

RAL 7030  
Gray  
Full Gloss

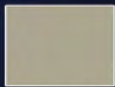

RAL 7032  
Gray  
Full Gloss

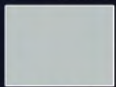

RAL 7035  
Gray  
Full Gloss

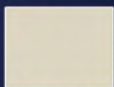

RAL 9002  
Gray  
Full Gloss

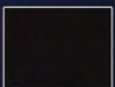

RAL 9011  
Black  
Sand Texture

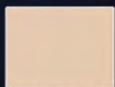

RAL 9010  
White  
Full Gloss

Note: Colors are close representations with standard monitor settings and are not intended for match. Color charts may also vary by manufacturer.

Semi-Gloss = 60 to 70 Gloss Level acc. to ASTM 523 / 60° angle  
Full Gloss = 80 to 90 Gloss Level acc. to ASTM 523 / 60° angle

Distribuidor Autorizado - Mexico

Tel. 01(921)1634-977

info@siicomsa.com